

ILIFE-X1000

Robotic vacuum cleaner

User Manual

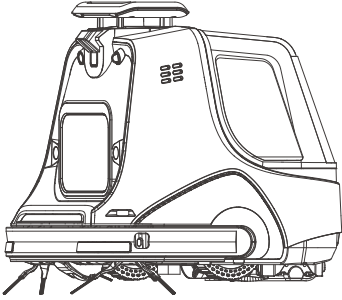

For more detailed information,
please visit: www.iliferobot.com | **ILIFE**

Dear Customer,

Thank you for purchasing ILIFE X1000 robotic vacuum cleaner!
You've joined the millions of people who clean with robots - the smarter way to get it done.

Please take a few moments to read this manual and get acquainted with your robot, to get the best performance from your robot. If you have any problems with your robot please do not hesitate to contact our customer service or visit our website at www.iliferobot.com for more information. Stay connected with us on Facebook and Twitter to enjoy these exclusive benefits:

- Get support tailored to your specific robot, including answers to questions, maintenance tips, video demos, live chat and more.
- Get product updates and other valuable information among the first to find out about new robots, exclusive discounts and special promotions.

Connect with us right now at
Facebook: <https://www.facebook.com/ilifeglobal>
Twitter: https://twitter.com/ilife_global

Enjoy a thorough cleaning every day!
Best regards,
ILIFE Innovation

ILIFE Customer Service

Russia

 89299401228 (Mon-Fri: 9:00 - 18:00)

 service_russia@iliferobot.com

Other countries

 support@iliferobot.com

Table of Contents

Safety Instructions	3
Main Product And Parts	5
List of Accessories	5
Main Body	6
Product Operating	8
Preparation Before Using	8
Install the Battery	8
Charging Mode	9
Charging	10
Switch/Pause	10
Mode Selection	11
APP Download and Operation Instruction	12
APP Download	12
Connected APP	12
Unconnected APP	16
Control Robot	16
Maintenance	17
Side Brush Maintenance	17
Roller Brush Maintenance	17
Multi-directional Castor Maintenance	18
Dust Bin and Filters Maintenance	18
Filter Cleaning	19
Cliff Sensors and Charging Pins Cleaning	20
Maintenance and Replace Accessories Regularly	21
Technical Parameter	22

Safety Instructions

About Safety

1. This device is not suitable to be used by children under 8 years old and people with physical or emotional disabilities. If to use, please operate the device under the supervision of the guardian. Please don't let the child sit on the robot and play the robot as a toy.
2. Please remove obstacles before using the robot. Such as power cord and other items. Please fold the edge of the carpet under the carpet. And also do not let the curtain and tablecloth touch the floor.
3. If there are environment like stairs, please test the robot to see if it can detect the edge of the falling area without dropping.
4. Please follow the instructions to operate the robot.
5. Make sure the power supply voltage matches the voltage marked on the charging base.
6. Use only in indoor and home environments. Do not use in outdoor, commercial and industrial environment.
7. Only use the original rechargeable battery and charging base provided by the manufacturer. Non-rechargeable batteries are strictly forbidden to use. Battery specifications please refer to the technical parameters.

About Product

8. Do not flush the robot directly with water.
9. Do not wipe the robot with watery cloth.
10. Do not use on wet or watery floor.
11. Do not use in open fire and fragile environment.
12. Do not let the hair, cloth and fingers come close to the product's openings or operating parts.
13. Do not let the robot to suck any material that might block the device, such as stones, waste paper, etc.
14. Prohibit robot from absorbing any flammable materials, such as gasoline and toner for printer or photocopier.
15. Do not allow the product to absorb any products that are burning, such as cigarettes, matches, ashes and other products that may cause a fire.

Safety Instructions

16. Do not place the product on the sucking mouth. Do not use the robot if sucking mouth blocked. Clean up dust, hair, cotton, etc., to ensure the air at the sucking mouth flows smoothly.
17. Prohibit using the damaged charging base.
18. Use the power cord carefully to avoid damage. Do not use the power cord to drag and pull the product or its charging base. Do not allow the product to run on the power cord and keep the power cord away from heat source.
19. If the power cord is damaged, to avoid the danger, it must be replaced by the qualified maintenance staff.
20. Make sure the dust bin and filter are properly installed before using.
21. Do not use the robot in an infant sleeping room.
22. Do not use the robot when the product cannot work properly due to drop, damage, water, or outdoor use. And please let the robot repaired by the manufacturer and its service department.
23. If do not use the product for a long time, disconnect the power supply.

About Maintenance

24. Before cleaning and maintaining the product, please turn off the power switch first.
25. Before cleaning and maintaining the product, please pull the power cord out of power socket.

About Disposal

26. Before disposing of the product, please remove the product from the charging base, turn the power switch off and remove the battery.
27. Before disposing of batteries, you must follow local laws and regulations.
28. Even if the product is severely damaged, it is forbidden to incinerate the product and the battery may cause an explosion.
29. Please follow the instructions to use the product. Due to improper use of any loss and damage, the company will not take any responsibility.

Main Product And Parts

List of Accessories

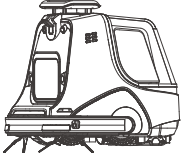

Host (With Two Batteries)

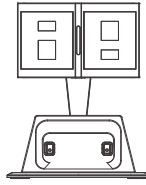

Charging Station

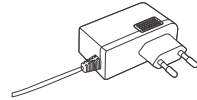

Power Adapter

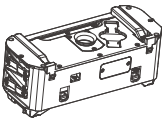

Suction Port Parts



User Manual



Front Roller Fluff
Assembly Parts

Main Product And Parts

Main Body

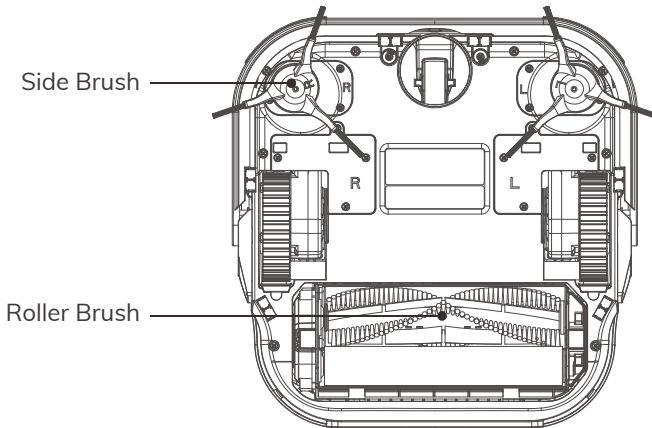
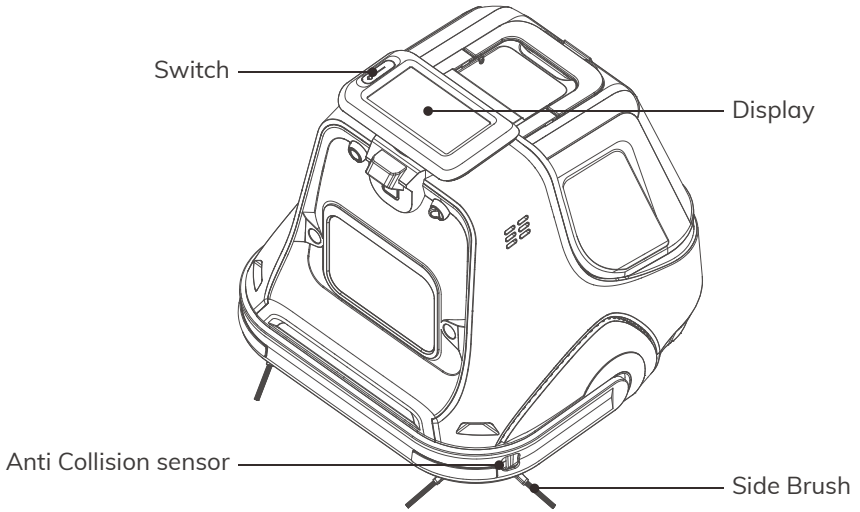

Main Product And Parts

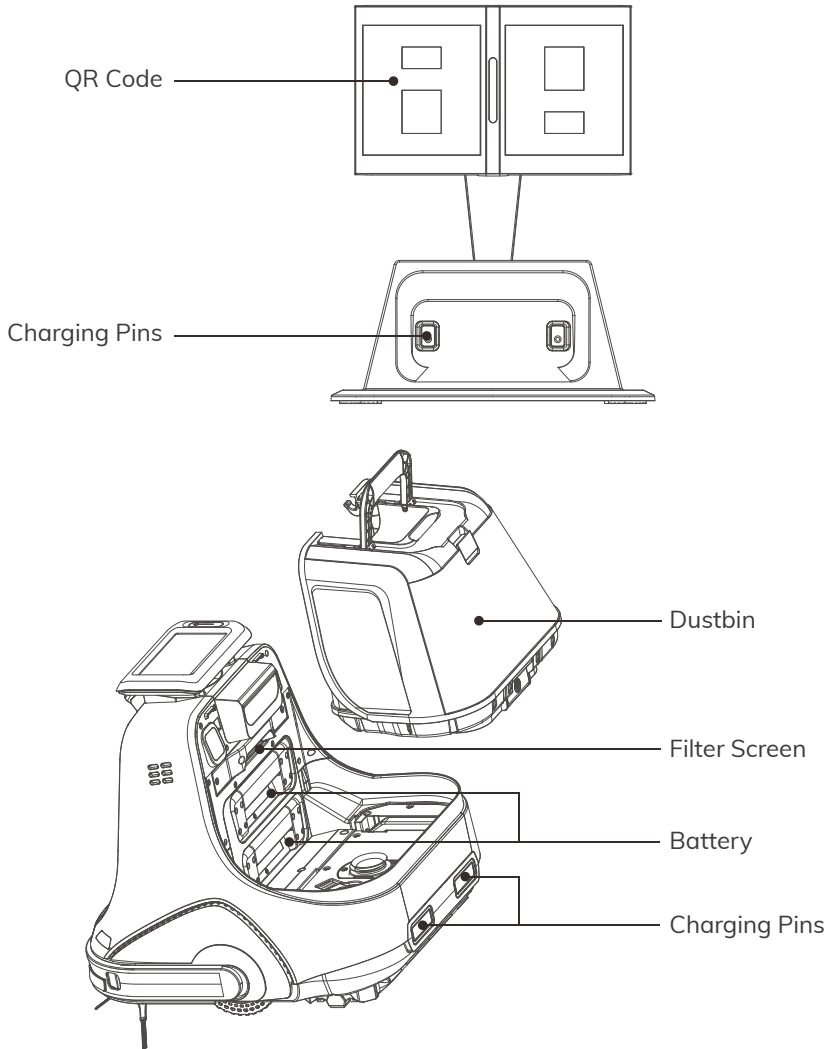

Product Operation

Preparation Before Using

- First, take the machine out of the packaging box; Second, lift the dustbin; Third, press the dustbin button to open the bottom cover of the dustbin; Finally, reach into the dustbin and take out the pearl cotton.
- Put the dustbin back on the host.

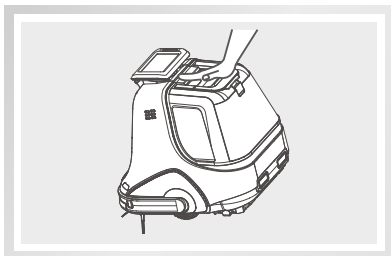
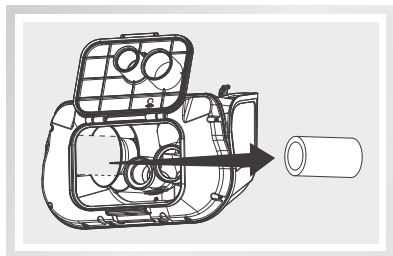
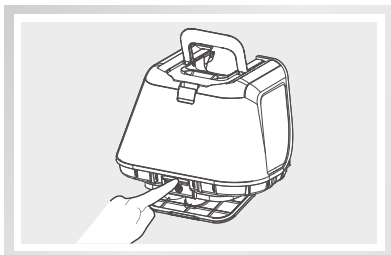
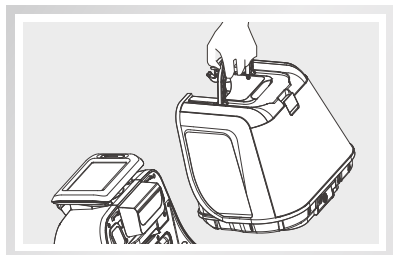

Install the Battery

Lift up the bin, put the battery into the battery slot according to the direction and press both sides of the battery with your hand at the same time to hear a "click". When you hear the "click" sound, the battery is successfully installed.

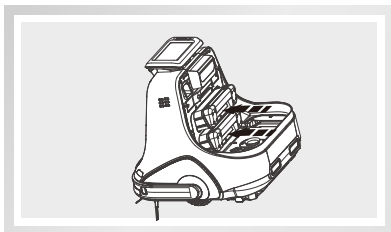
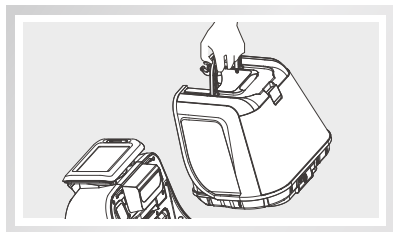

Product Operation

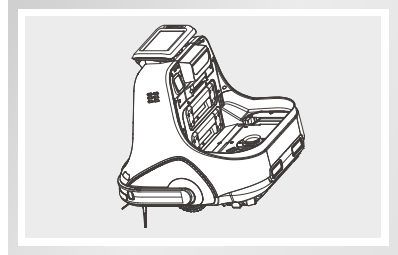
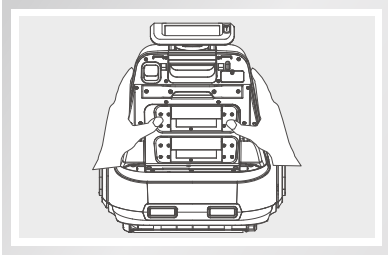

Charging Mode

- Connect the adapter and charging station.
- Place the charging station flat against the wall, the surrounding area is open and should not be covered by objects.
- Connect the power.

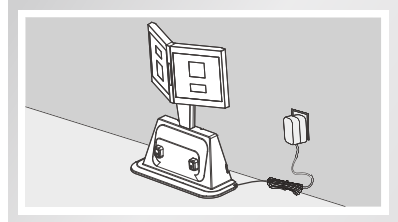
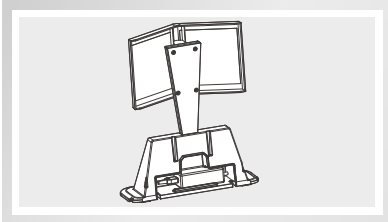

- Press the host switch button.

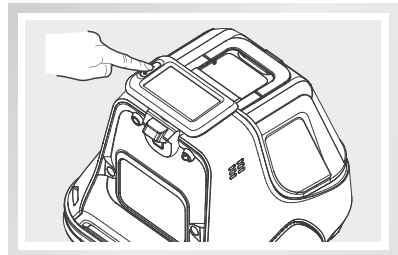

Tips:

After finished cleaning, it is recommended not to turn off the robot; keep the robot in charging station so that it can better perform in next time.

Product Operation

Charging

1 Auto charge

Press the recharge button  on the robot panel or APP, the device will automatically search for the charging base to charge.

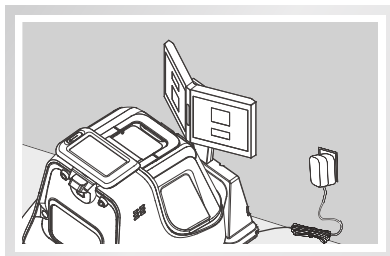

Tips:

During daily use, pay attention to cleaning the charging pin of the charging station, otherwise the charging effect will be affected.



Tips:

1. In daily use, please place the robot on the charging station, and ensure that the charging station is connected to the power supply and the host power switch is on.
2. If the robot is not used for a long time, please fully charge the machine, turn off the power, and store it in a dry and ventilated place.

Switch/Pause

2 Switch

- Make sure the power is on
- Press the button  on robot & APP to start cleaning.



Tips:

If the robot is in sleep mode, press  again to wake up the robot to enter function selection mode, press the button again then the machine will start working automatically.

Product Operation

3 Pause

- Press the button  on robot & APP to pause cleaning.



Tips:

The machine can be re-operated after the machine has been paused.



Mode Selection

1 Energy Saving

Press the energy saving button  on the robot.

2 Standard Mode

Press the standard button  on the robot.

3 Strong Mode

Press the power button  on the robot.

4 Max

Press the MAX button  on the robot.

5 Customize

Press the customize button  to customize the side brush, roller brush, volume, suction value.

APP Download and Operation Instruction

APP Download

The robot can be controlled by the “ILIFEHOME” app. Scan the QR code to install the app on your iOS or Android device.



Connected APP



Tips:

Connect your phone to an available WiFi network in the room
Make sure your phone is connected to an available WiFi network indoors and has a good signal quality.

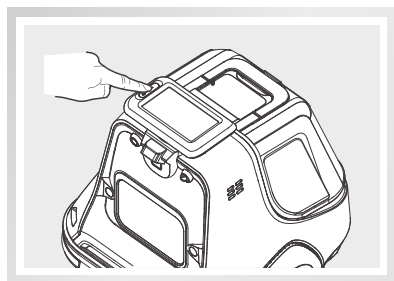

1 Turn on the robot to enter the standby situation



2 Click the machine menu button.

APP Download and Operation Instruction



- 3 Click the WLAN button on the machine or select the Settings button, and click Settings to enter the WLAN.



- 4 Click to use AP network



- 5 Click OK, the device will prompt "WIFI connecting".



- 6 The robot prompts: the network is being configured.

APP Download and Operation Instruction



1 Select country or region



2 Registered email account (read and agree with User Registration Agreement).

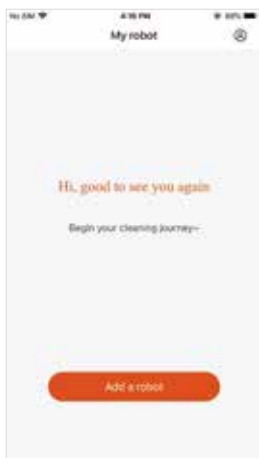

3 Click to add the robot



4 Click next

APP Download and Operation Instruction



- 5 Fill in the WIFI password and click next



- 6 Click Settings to jump to the phone settings page, click WIFI settings and select the wireless network from host: adh-XXx



- 7 The connection is successful, the binding is completed



Note:

If the connection fails, please restart the device and follow the steps to configure the network again.

APP Download and Operation Instruction

Unconnected APP

- On the device list page of APP, press and hold the device you want to unconnected and swipe to the left. An unconnected button will appear on the right side of the device.
- Click the Unbind button to unbind the device.



Control Robot

Click to select the device you want to control in the device list to enter the device control page.

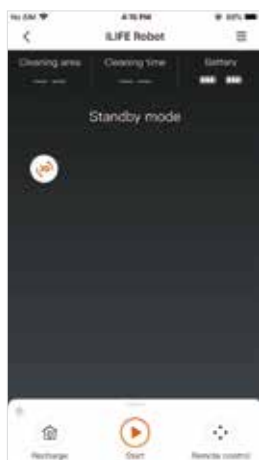

Maintenance



Note:

When cleaning and maintaining the device and accessories, please turn off the device and unplug the power supply of the charging station.

Side Brush Maintenance

Remove the side brush and wipe with a clean cleaning cloth.

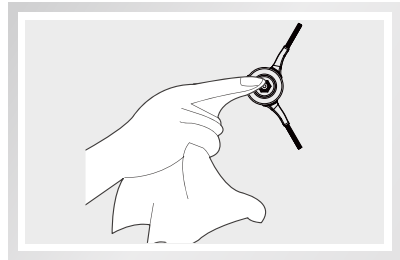

Roller Brush Maintenance

Remove the dustbin, lift out the roller brush box, hold the two buttons with your hands, pull out the plug, and use the clean tool to cut the hair wrapped around the roller brush.

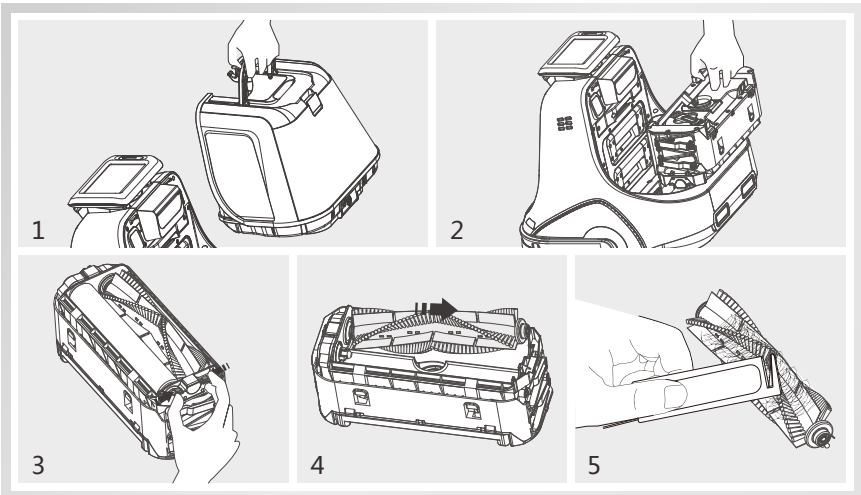

Maintenance

Multi-directional Castor Maintenance

Remove the castor and clean it to reduce the entanglement of hair and other particles.

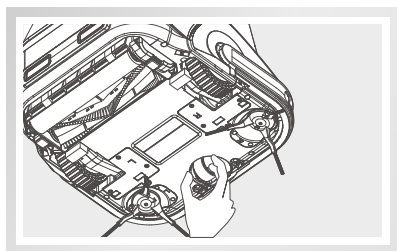

Dust Bin and Filters Maintenance

- 1 Please clean the dustbin in time after each use.
- 2 Remove the dustbin, press the button on the dustbin, after the bottom cover of dustbin pops up automatically, empty the dust inside.
- 3 Remove the filter from the dustbin, wash the filter with clean water, and make sure it is completely dry when reinstalling the filter.

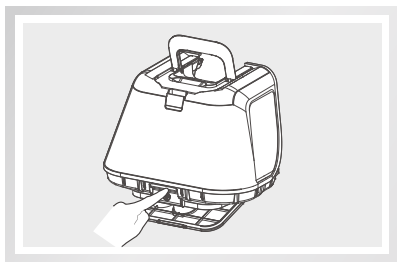
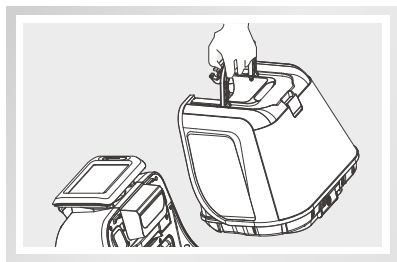

Maintenance

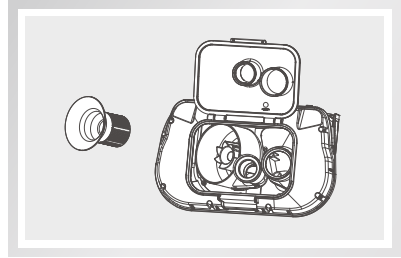
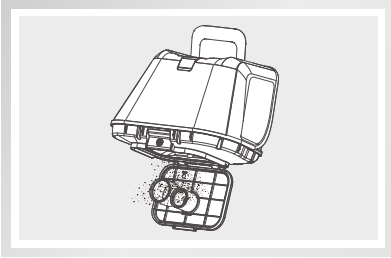

Filter Cleaning

Remove the high-performance filter, wash with clean water, and place in a cool, ventilated place to dry, do not squeezing the high-performance filter.

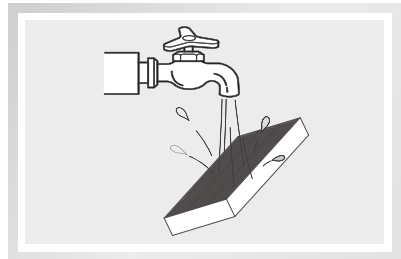
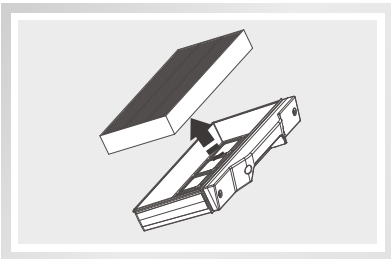
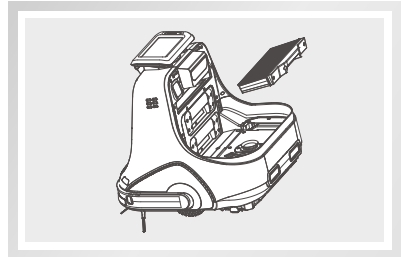
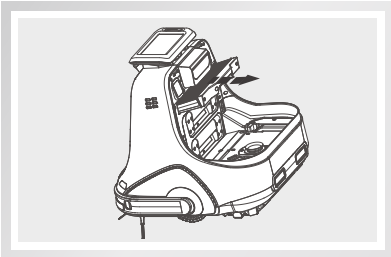

Maintenance

Cliff Sensors and Charging Pins Cleaning

Gently wipe the sensor and battery connector with a cleaning tool, as shown in the picture:

**Tips:**

Clean the charging pins in time when there is dust on the cover.

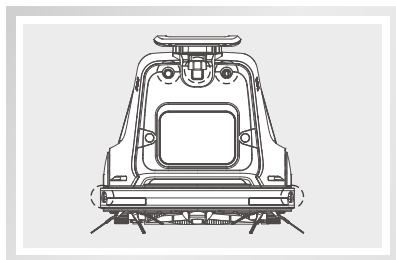
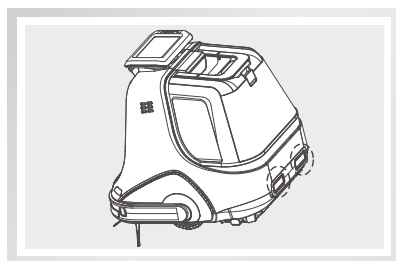
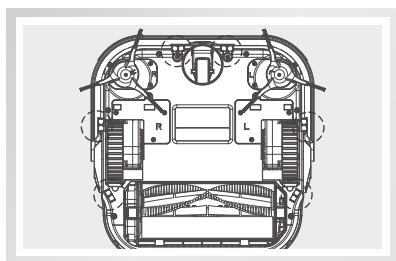
**Tips:**

- When the device not use for a long time, please take out the battery and keep it properly. If the battery leaks, please remove the battery and wipe the battery.
- This device uses a long-life battery and does not need to be replaced frequently. If you need to replace it, please contact our after-sales service.

Maintenance

Maintenance and Replace Accessories Regularly

Parts	Cleaning	Change Into New One
Dustbin	After each use	No
Filter	Once a week (twice a week for pet families)	Replace the new one every three to five months
Roller Brush	Once a week (twice a week for pet families)	According to actual needs
Side Brush	Once a week	According to actual needs
Charge Station	Once a week	No

Technical Parameter

Product name	Commercial Robot Vacuum Cleaner
Model	X1000
Nominal voltage (V)	DC 25.2V
Motor power (W)	250W
Charging voltage (V)	32V
Charging time	<300min
Battery capacity (mAh)	4700mAh
Product size (mm)	377x373x361mm
Maximum vacuum (kPa)	20kPa
Net weight (Kg)	11.3
Working times (Min)	210Min
Dust cup capacity (L)	3L

