

ILIFE-A80 Max

Robotic vacuum cleaner

User Manual

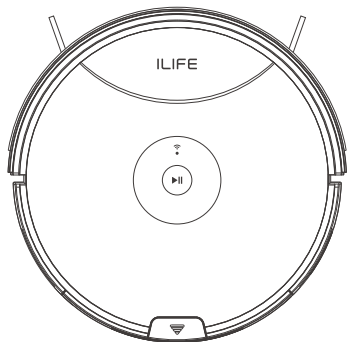

For more detailed information,
please visit: www.iliferobot.com | **ILIFE**

Dear Customer,

Thank you for purchasing ILIFE A80 Max robotic vacuum cleaner! You've joined the millions of people who clean with robots - the smarter way to get it done.

Please take a few moments to read this manual and get acquainted with your robot, to get the best performance from your robot. If you have any problems with your robot please do not hesitate to contact our customer service or visit our website at www.iliferobot.com for more information.

Stay connected with us on Facebook and twitter to enjoy these exclusive benefits:

- Get support tailored to your specific robot, including answers to questions, maintenance tips, video demos, live chat and more.
- Get product updates and other valuable information among the first to find out about new robots, exclusive discounts and special promotions.

Connect with us right now at
Facebook: facebook.com/iliferobotics
Twitter: twitter.com/LIFEROBOTICS

Enjoy a thorough cleaning every day!
Best regards,
ILIFE Innovation

Table of Contents

Safety instructions	3
Product composition	5
List of accessories	5
Robot anatomy	6
Dustbin	7
Water tank	7
Charging dock	8
CLEAN button status	8
Remote control operating	9
Product specifications	11
Product operating	12
Charging dock	12
Start/Pause/Sleep	14
Mode selection	15
Schedule mode	18
Water tank operation	20
APP download	22
Maintenance	23
Cleaning side brushes & main brush	23
Cleaning sensors & charging pins	23
Cleaning the nose wheel	24
Cleaning dustbin & filter	24
Cleaning mop cloth & water tank	25
Replace accessories regularly	26
Troubleshooting	27
Error code sheet	27

Safety Instructions

Before using this product, please read the following safety instructions and follow all normal safety precautions.

- Read this user manual thoroughly and carefully before using this product.
- Keep this user manual.
- Any operation or use of this product in any way other than that described in this manual may lead to serious injury or product damage.

WARNING

1. Only certified technicians may disassemble the product. Users are not allowed to disassemble or repair the product.
2. Only use the AC adapter provided by the factory. Using other AC adapters may cause electric shock, fire or product damage.
3. Do not touch the power cord, plug or adapter when your hands are wet.
4. Keep loose clothing and fingers away from being drawn into the product's wheels.
5. Keep the robot vacuum away from all flammables.
6. Never clean the robot while it is on the charging dock or plugged in directly. Unplug the robot and turn off power switch when cleaning.
7. Keep the AC power cord tucked away from becoming damaged in any way.
8. This product is to be used only indoors. Not intended for outdoor use.
9. Do not sit on top of the product or attach an object on the top of it.
10. Do not use this product in wet or moist environments.
11. Before use, remove all the objects that could get caught in the brushes or suction passage.
12. Do not place this product on furniture or platforms where it can fall and be damaged.
13. Turn the power switch off when not in use for a long period of time or when transporting the unit.
14. To avoid battery damage please check whether adapter and outlet are properly connected.

Safety Instructions

15. To avoid any tripping hazards or injuries please inform all the people in the house when this product is in use.
16. Do not use this product when dustbin is full.
17. Normal operating temperatures -10 to 50 (centigrade).
18. Do not operate this product in high temperature environments.
19. The battery must be removed from the product before it is scrapped.
20. Unplug the vacuum from power source when removing the battery.
21. The battery is to be disposed of safely.
22. Use factory authorized battery only. Do not use unmatched battery.

**NOTE:**

This product is not a toy and should not be used by children or people with the lack of related experience or knowledge.

Product Composition

List of accessories

Serial Number	Description	Q'ty
1	Main Body (battery included)	1
2	Charging Dock	1
3	Remote Control (battery not included)	1
4	Power Adapter	1
5	Water Tank	1
6	Mop Cloth	1
7	Cleaning Tool	1
8	User Manual	1
9	Extra Side Brushes	2
10	High Performance Filter	1

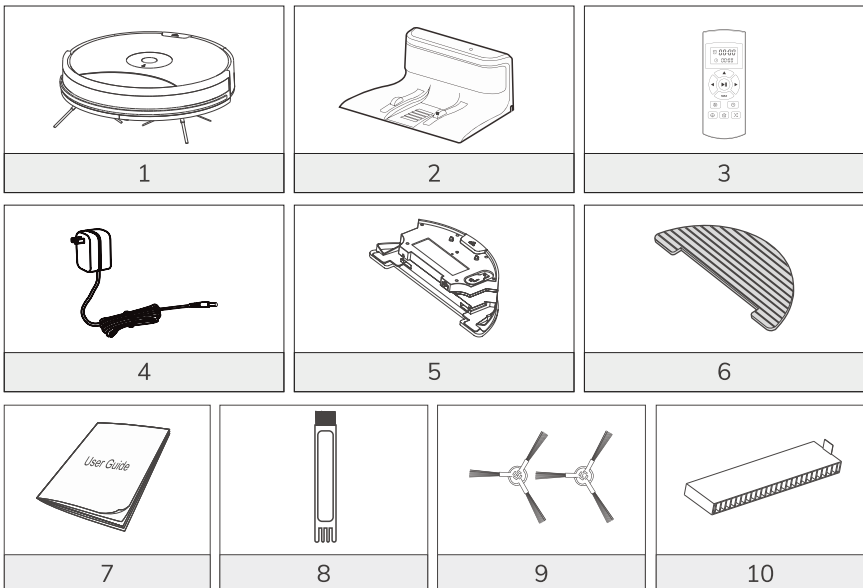

Product Composition

Robot anatomy

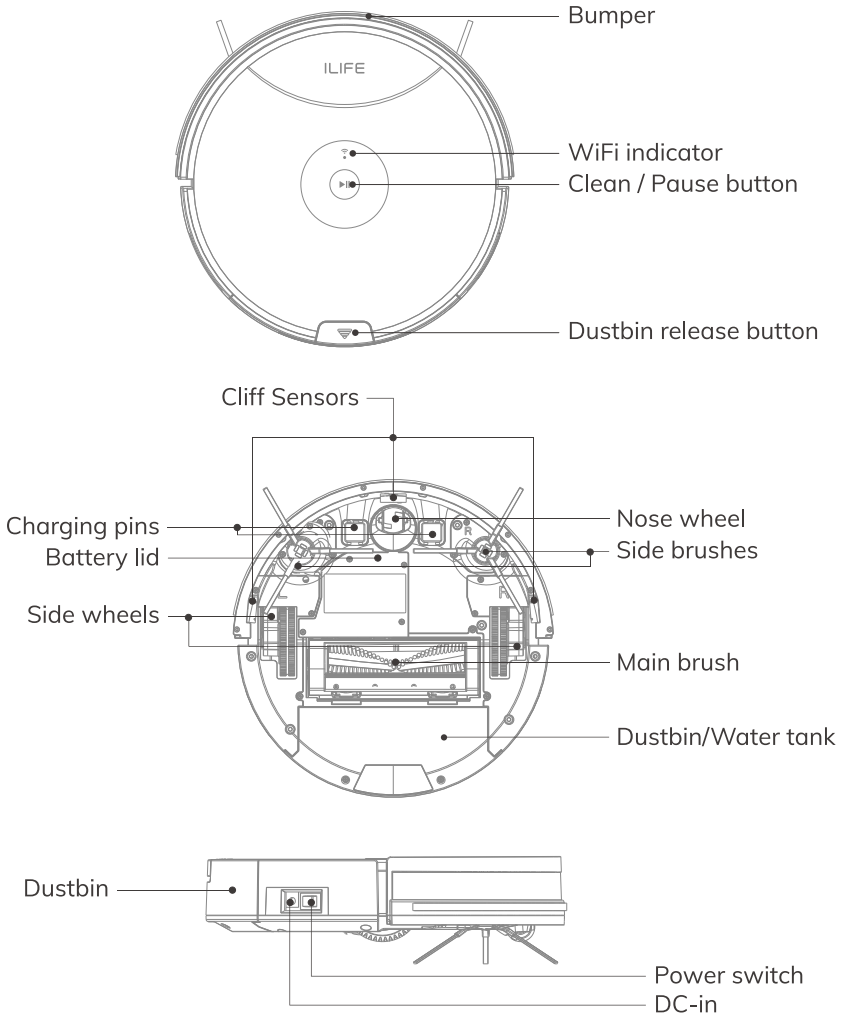

Product Composition

Dustbin

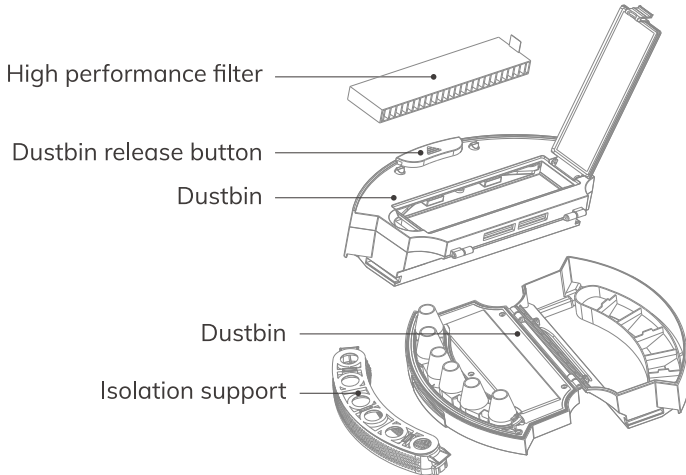

Water tank

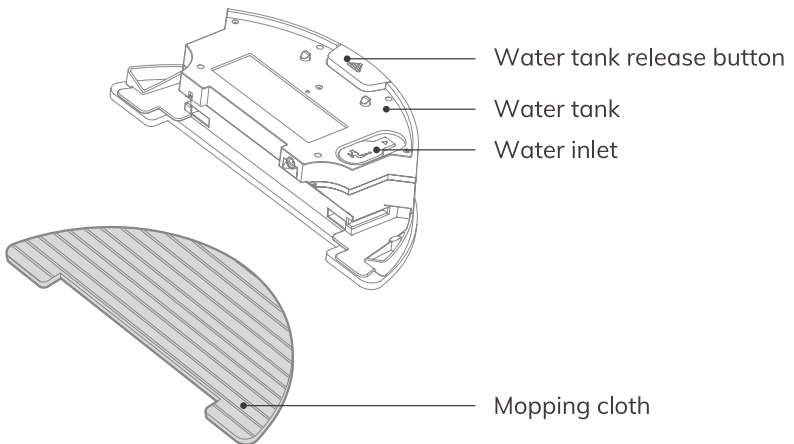

Product Composition

Charging dock

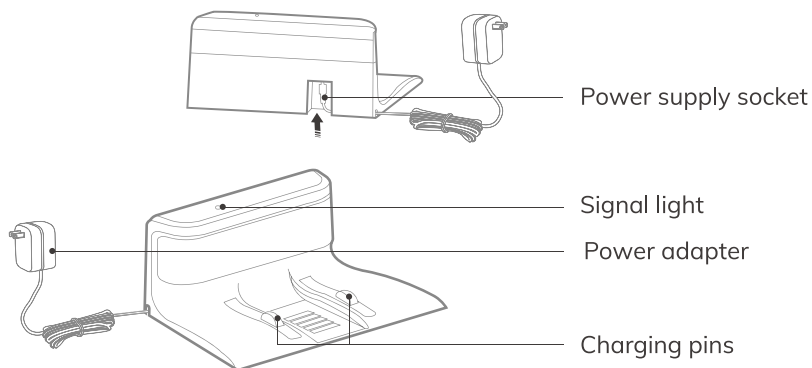

CLEAN button status

Robot status	Color indication
Charging	Orange light flashes
Charging finished	All lights off
In selected mode	Green light flashes
When robot in error	Red light turns solid
Low battery	Orange light turns solid
In home mode	Orange light turns solid
In classic mode	Green light turns solid
In path mode	Green light turns solid
In edge mode	Green light turns solid
In spot mode	Green light turns solid

Product Composition

Remote control operating

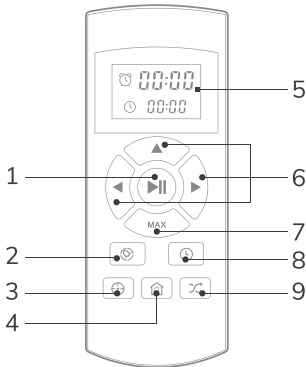

1. Starting up/Pause
2. Plan
3. Spot mode button
4. Auto charge button
5. Display screen
6. Directional buttons
7. MAX mode button
8. Clock
9. Edge mode/Classic mode button

1 “▶||” Clean

- Press the button to switch the robot from Sleep Mode to Select Mode.
- Press the button when in Select Mode to start cleaning.
- Press the button to Pause the robot during its operation.

2 Directional buttons

A. “▲” Button:

- To increase minute and hour setting in schedule or clock mode.
- To move robot forward in select mode.
- To stop the robot when it hits against objects.

B. “MAX” Button:

- To decrease minute and hour setting in schedule or clock mode.
- In select mode or cleaning mode, press the button to maximize vacuum power, press again to normal vacuum power.

C. “◀” Button:

- To change from minute to hour in schedule or clock mode.
- In select mode, classic cleaning mode or auto charging mode, press the button to turn the robot left.

Product Composition

D. “▶” Button:

- To change from hour to minute in schedule or clock mode.
- In select mode, classic cleaning mode or auto charging mode, press the button to turn the robot right.

3 Clock

- To enter clock mode when robot is in selected mode.
- To confirm time setting.

4 Plan

- To enter schedule mode when robot is in selected mode.
- To confirm cleaning schedule.

5 Auto charge button

Press the button and the robot will return to the charging dock for recharging.

6 Edge mode/Classic mode

Edge Mode: Press the button once to enter edge cleaning when robot is in selected mode.

Classic Mode: Press the button twice to enter classic cleaning when robot is in selected mode.

7 Spot mode

Press the button to start the spot cleaning.

8 00:00 Shows the scheduling time.

9 00:00 Shows the clock time.



Note:

1. Install two AAA type batteries into the remote control.
2. Take out the batteries if the remote control is not used for long time.

Product Composition

Product specifications

Classification	Item	Detail
Mechanical specifications	Diameter	330mm
	Height	80mm
	Weight	2.5kg
Electrical specifications	Power	22W
	Battery type	Li-ion
	Charging type	Auto charging / Manual charging
Cleaning specifications	Capacity of dustbin	0.45L
	Capacity of water tank	0.3L
	Cleaning mode	Spot, Classic, Edge, MAX, Daily schedule
	Charging time	≤360mins
	Cleaning time	≥100mins
Main Body Button Type		Mechanical button



Reminder:

The Company reserves the right of final decision on the interpretation of these Terms and Conditions.

Product Operation

Charging dock

1 Placement of charging dock

- Connect the adapter with the charging dock.
- Placement of the charging dock: place the charging dock against the wall horizontally and there must be no object on the left and right side within one meter and in the front within two meters. There must also be no reflective object such as a mirror around the dock.
- Connect the power.

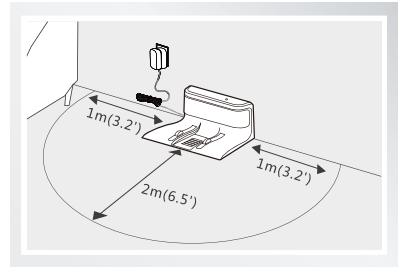
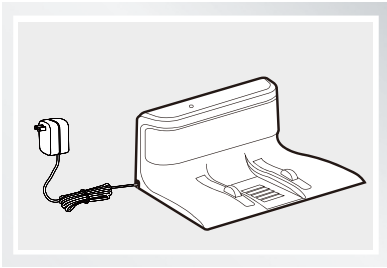

Reminder: When the charging dock is connected to the adapter, the signal light of the dock will light up.

2 Turn on the robot

- Turn on the power button on the side, “-” for ON, “O” for OFF.

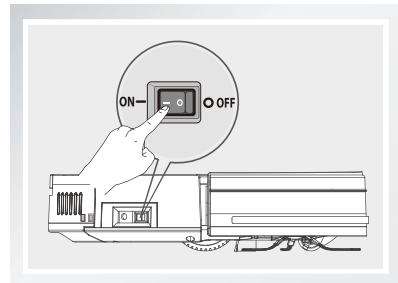

Reminder: After the robot finishes its work, please do not turn it off; keep it recharged for next run.

Product Operation

3 Robot charging

A. Auto charging

- Under the Auto Mode, the robot will automatically search for the charging dock when the power is low.
- Under the selected mode, the robot will begin to search for the charging dock when the respective button  on the remote control is pressed.

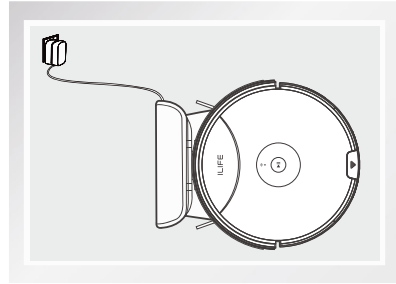

Reminder: Please keep the charging pins clean in daily use to ensure a good connection.

B. Manual charging

- Turn on the power button on the side of the robot, connect the adapter with the robot and then plug the adapter into the power socket.

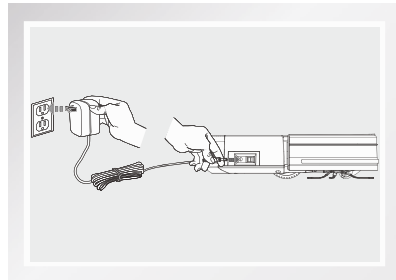

Reminder:

- Charge for 6 hours for the first time.
- Please leave the robot on the charging dock in daily use and make sure that the charging dock is connected to the power and the main switch is on.
- If you won't use the robot for a long time, please fully charge it, turn off the power and store it in a well-ventilated dry place.
- Please don't use manual recharge mode under the Schedule Mode, otherwise the robot can't perform the function of Schedule Mode.

Product Operation

Start/Pause/Sleep

Sleeping mode: robot is not working, light at  button is off and power switch is on.



Selected mode: robot is not working, green light at  button flashes.

Cleaning mode: robot is working, green light at  button turns solid.

1 Starting up

- Make sure that the power switch on the side of the robot is "ON".
- Press  button to start operation.



Reminder: If the robot is in the Sleep Mode, press button  to wake up the robot and enter the Select Mode, then press button  once again, and the robot will automatically start operation.

2 Pause

- "Pause" will switch the robot from Cleaning Mode to Select Mode, and it can be enabled by pressing button  on the robot or remote control.



Reminder: You can operate the machine again after it's paused.

3 Sleep

- To enter the Sleep Mode:
 1. Press button  for three seconds.
 2. The machine will automatically enter the Sleep Mode if no action is taken for 10 minutes.

Product Operation

Mode selection

There are several cleaning modes to fit various floor conditions for deep cleaning. You can make a choice with the remote control.



- You can use the remote control to switch between various modes.
- You need to make sure that the robot is awake before starting any of the following modes. The power is on, the button light is green, and the robot is paused.

1 Path mode

The most frequently used cleaning mode. Press  on the main body or remote control. Robot plans a path and cleans along a zigzag pattern. During cleaning, robot detects and cleans areas that have been missed.

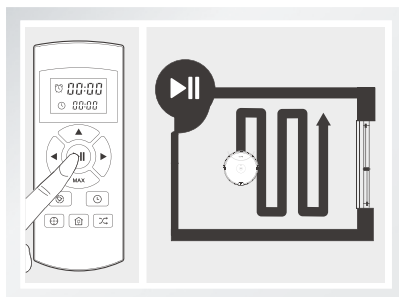

Reminder:

- Robot plans a cleaning path autonomously during a cleaning cycle. If robot is moved manually or with the remote control, it will plan a new path and may repeat areas that have been cleaned.
- Robot may stop working briefly during a cleaning cycle. Wait patiently for it to detect areas that have been missed or to revise the cleaning path. The number and duration of these brief stops depend on the complexity of the home environment.

Product Operation

2 Spot mode

Place the robot near the required area, and then press the button  on the robot to start cleaning in Spot Mode.

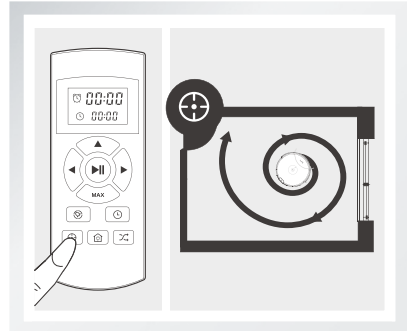

3 Edge mode/Classic mode

- Edge Mode: Press the button once to enter edge cleaning when robot is in selected mode. (Refer to Figure 1)
- Classic Mode: Press the button twice to enter classic cleaning when robot is in selected mode. (Refer to Figure 2)

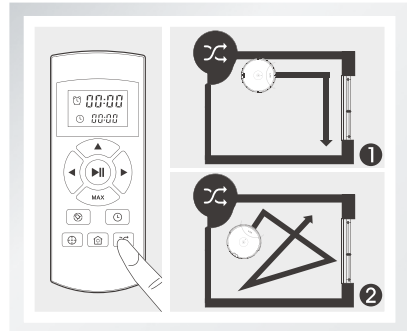

4 MAX mode

It is suitable for the environment where the whole ground is dirty and with more dust. Press the "MAX" button of the remote control to increase the suction of the robot. Press the "MAX" button again to switch to normal suction.

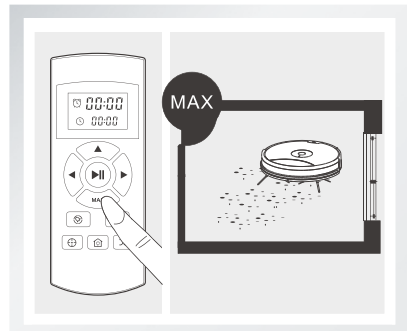

Product Operation

5 Auto charge mode

The robot can sense lower power during the cleaning process and automatically activate Self-charge Mode and search for the charging dock.



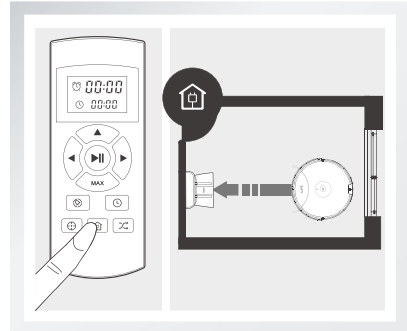

You can also use the button  on the remote control to command the robot to activate the mode.



Product Operation



Schedule mode

To offer a complete automatic cleaning experience, robot receives preset cleaning schedules. Set local time and schedules with the remote control. Robot will start cleaning automatically at the preset time every day.

Before setting local time and cleaning schedules, make sure  on the main body is switched on. A green flashing light indicates robot is activated from Sleep mode. To activate robot, tap  on the main body or remote control.

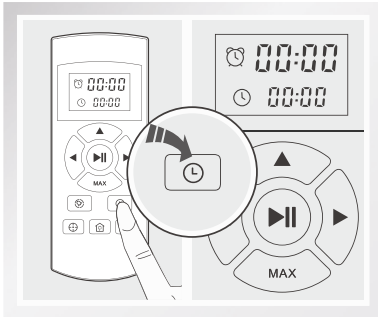
1 Set local time with remote control



Tap  button. Remote control display will show  and flashing 00:00.

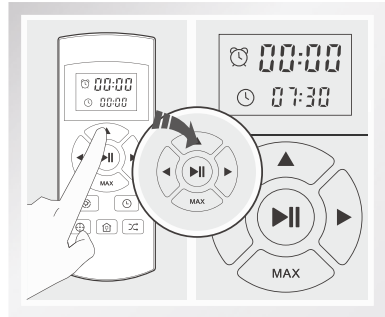

Adjust time with “▲” “MAX” button. To set local time, press “◀” “▶” to change from hours to minute.

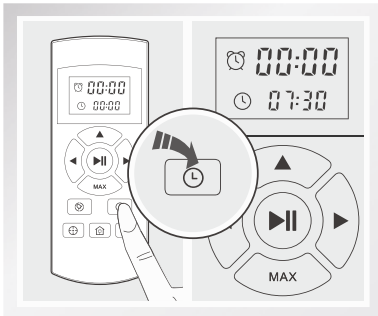

Press  to save local time. Successful setting will be confirmed by a “beep” sound.

Product Operation

2 Set a schedule

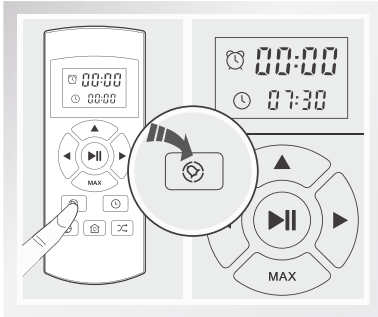

Tap . Remote control display will show  and flashing 00:00.

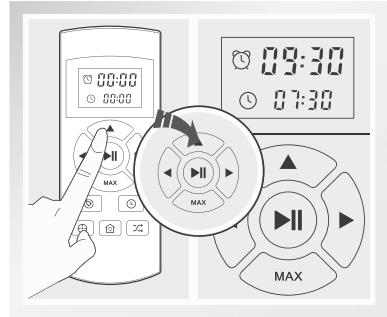

Use direction buttons to adjust schedule time.

Press  to save a schedule. Successful scheduling will be confirmed by a "beep" sound. And robot will start working at the preset times.

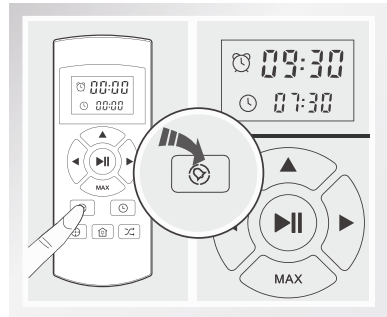

3 Cancel a schedule

Adjust time to "00:00" and save; or turn off the power switch on the main body.

- Please pay attention to the prompt to see if the robot is successfully scheduled.
- Rescheduling is required after changing batteries in the remote control.

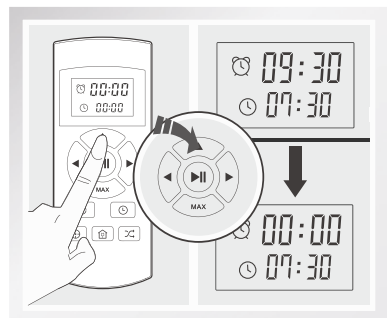

Product Operation

Water tank operation

The product is equipped with water tank components, and if there is a demand for the mop, it is recommended to clean the area with the dustbin first. Then change the dustbin to the water tank components to carry out the mop work.



- * If during the mopping process the robot is stopped to either add water or clean the mop, the robot will reset and plan a new pathway from where it is started. In order to achieve a better cleaning, it is recommended for single room use.
- * When cleaning a second room, it is recommended to manually move the robot to the corresponding room and add water and clean the cloth as needed.

- * Please do not use the water tank components on the carpet or rugs. Please fold the edge of the rugs or block carpet areas to avoid cleaning them during the mopping mode during the mopping mode.
- * Please pay attention during the mopping mode, timely add water or clean the mopping pad. The water tank needs to be removed when adding water.
- * Be sure to remove the water tank components when charging.

1 Add water

- Open the water injection cap, fill the water with the water cup, and pour the water slowly into the tank.

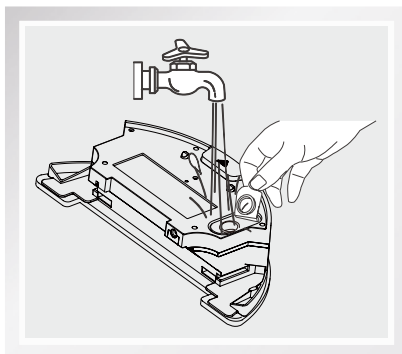

Product Operation

2 Place the mop cloth

- Close the water injection cap tightly, put on the mop cloth and strap the two elastic bands.

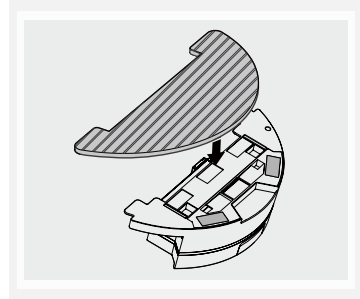

3 Install water tank components

- Press the button at the end of the dustbin, remove the dustbin, and replace it with the water tank components.

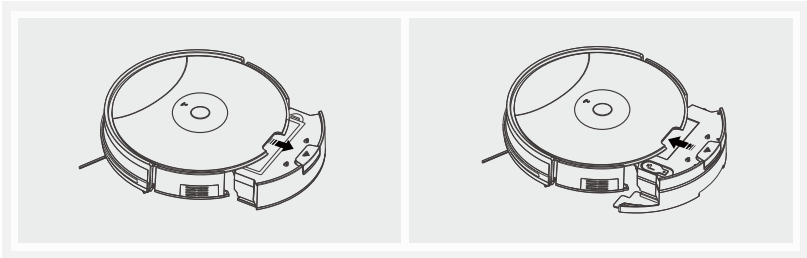

4 Mop the floor

- Start any cleaning mode on demand, and the robot will perform mopping.

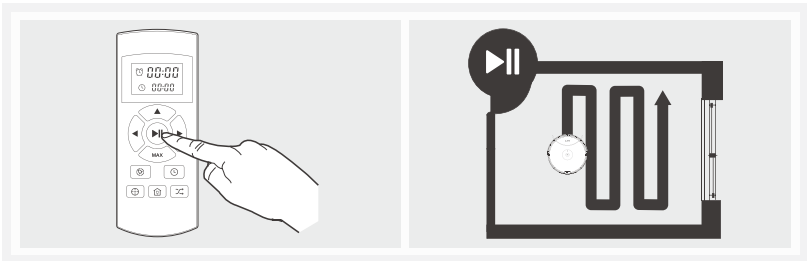

APP Download

Downloading the APP

The robot can be controlled by the “ILIFEHOME” app. Scan the QR code to install the app on your iOS or Android device.



Maintenance



Reminder: Make sure the main body is turned off and adaptor is unplugged before accessories maintenance.

Cleaning side brushes & main brush

Cleaning side brushes

- Remove side brushes. Wipe clean with a clean cloth.
- When replacing the side brush, please distinguish the corresponding installation position of the "L" "R" side brush.

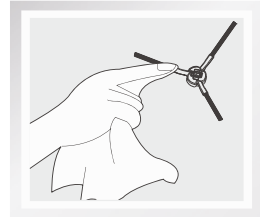

Cleaning main brush

Remove main brush cover. Take out main brush. Cut the hair winding around the brush for easy removal.

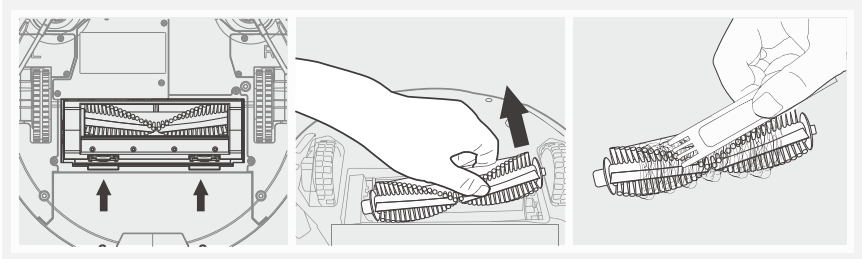

Cleaning sensors & charging pins

Use cleaning tools or a soft cloth to clean the sensors and charging pins:

Note: Remove dust or foreign objects on sensors and charging pins on the charging dock as soon as possible.

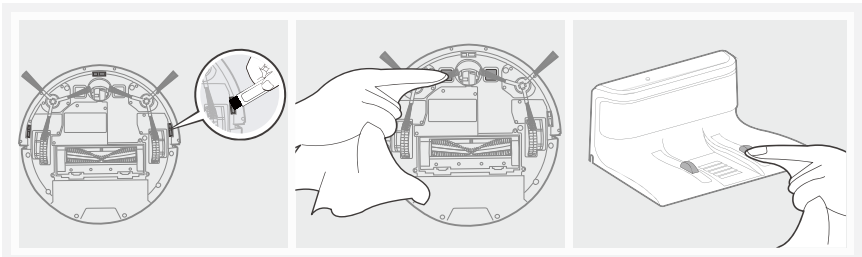

Maintenance

Cleaning the nose wheel

Clean the nose wheel with the enclosed cleaning tool.

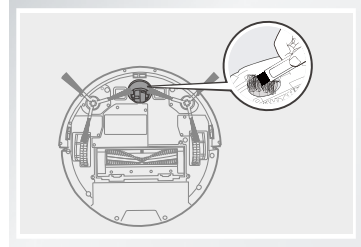

Cleaning dustbin & filter

Please clean the dustbin and filter after each use of the robot as instructed below.

- Remove the dustbin and check if there is any debris in the suction inlet, and then clean it.
- A primary filter is replaceable and should be washed with water after having been in use for about 15-30 days, after which it should be dried in a cool and well-ventilated place and not to be squeezed.
- High Performance Filter can not be cleaned with water. To prolong the life of the filter it can be cleaned by shaking the filter.

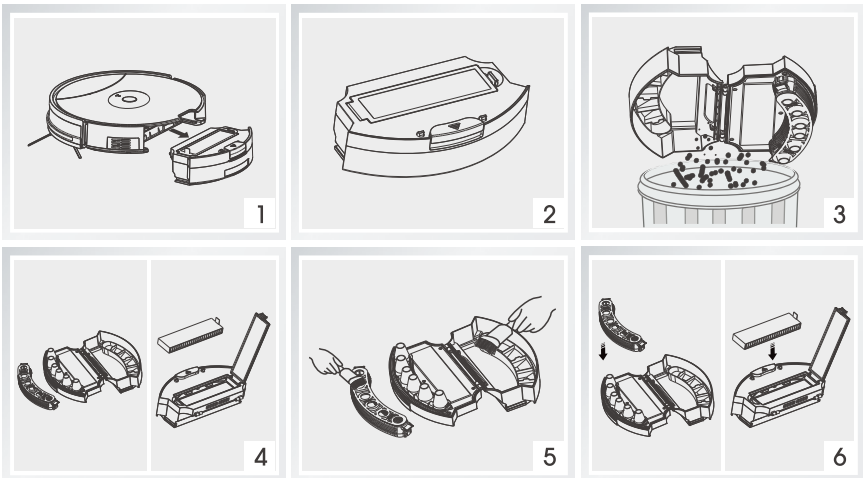

Maintenance

Cleaning mop cloth & water tank

1 Cleaning mop cloth

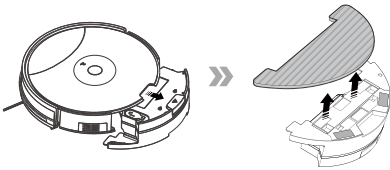

Remove: after mopping, please remove the water tank components and the mop cloth.

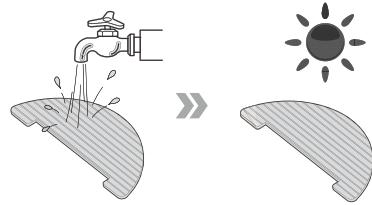

Maintenance: rinse and air dry the mop cloth.

2 Cleaning water tank

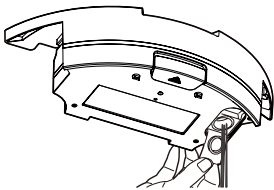

Remove: after mopping, remove the mop cloth and the components, drain the remaining water in the water tank.

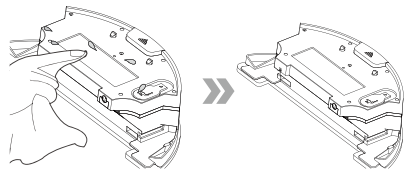

Maintenance: dry the water tank byhand and then air dry it.

Maintenance

Replace accessories regularly

Accessories	Maintenance	Replacement
Dustbin	After each use	N/A
High performance filter	Weekly (Twice a week for families with pets)	Bimonthly
Spinning side brush	Weekly	Depends
Charging dock	Weekly	N/A

Troubleshooting

Error code sheet

When the robot meets with some routine troubles, it will remind you by beep.

- Short tone

NO.	Tone	Cause	Solution
01	•	Wheels or side brushes no work	Check wheels or side brushes
02	• •	Cliff sensor or bumper sensor failure	Clean cliff sensor and shake bumper slightly, check whether there is foreign matter
03	• • •	Main body gets stuck	Move main body and start again