

ILIFE-V9e

Robotic vacuum cleaner

User Manual

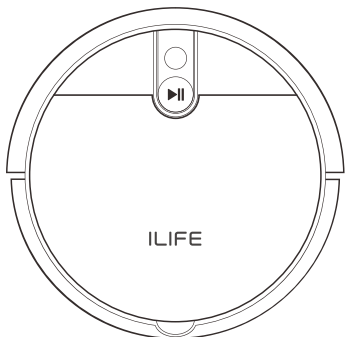

For more detailed information,
please visit: www.iliferobot.com | **ILIFE**

Dear Customer,

Thank you for purchasing ILIFE V9e robotic vacuum cleaner!
You've joined the millions of people who clean with robots - the smarter way to get it done.

Please take a few moments to read this manual and get acquainted with your robot, to get the best performance from your robot. If you have any problems with your robot please do not hesitate to contact our customer service or visit our website at www.iliferobot.com for more information.

Stay connected with us on Facebook and twitter to enjoy these exclusive benefits:

- Get support tailored to your specific robot, including answers to questions, maintenance tips, video demos, live chat and more.
- Get product updates and other valuable information among the first to find out about new robots, exclusive discounts and special promotions.

Connect with us right now at
Facebook: facebook.com/iliferobotics
Twitter: twitter.com/ILIFEROBOTICS

Enjoy a thorough cleaning every day!
Best regards,
ILIFE Innovation

Table of Contents

Safety Instructions3

Product Composition5

List of accessories5

Robot anatomy6

Dustbin8

Remote control8

Product specifications9

Product Operating10

Attentions10

Charging dock12

Select cleaning modes16

Schedule cleaning18

APP Download20

Maintenance21

Clean up dustbin and filters21

Clean up the side brushes22

Clean up the HEPA filter22

Install dustbin and filter23

Other spare parts24

Replace accessories regularly25

Troubleshooting26

Error codes26

Error symptoms27

Safety Instructions

Warnings

1. This robot should not be used by children under 8 or people with mentally challenged, unless they are under supervision. Do not let children sit on the robot or use it as a toy.
2. Attend to the robot promptly if an error occurs during cleaning. Before using the robot, remove all power cords and small objects on the floor. Roll up carpet tassels and make sure curtains and table cloth are not in contact with the floor.
3. If there are hanging steps or stairs, please test if the robot can detect them before use. If not, please set up barriers to avoid falling down, and make sure that the barriers cause no harm to people.
4. Follow the instructions in this user manual. Use factory authorized or recommended accessories only.
5. Make sure the voltage of the charging dock is compatible with the voltage of power supply.
6. Use the robot indoor and in a home environment only. Do not use it outdoor, or in commercial or industrial spaces.
7. Use factory authorized adaptor and charging dock only. Do not use non-rechargeable battery. Refer to “Product Specifications” section for details about battery standards.
8. Do not soak the robot in water and do not rinse the robot under the faucet.
9. Do not clean the robot with dripping wet cloth.
10. Do not use the robot on floors with ponding water.
11. Do not use the robot near fire or fragile objects.
12. Do not use the robot under extreme temperatures below -5°C or above 40°C .
13. Do not make the cloth, humans hair, finger, or other parts of the body close to the open or the running mechanism of the robot.
13. Do not use the robot on floors with stones or paper to avoid being stuck.
15. Do not use the robot in areas with any flammables, such as gasoline, toner and so on. Or use the robot to clean any burning objects, like cigarettes, ashes or matches, or anything that may cause a fire.
16. Do not use damaged charging dock.
17. Do not lift up the robot or the charging dock by the power cord, and keep the power cords away from heat and avoid it being trapped around doors, sharp edges or corners.

Safety Instructions

18. Damaged power cords must be repaired by manufacturer's repair service or certified technicians.
19. Install dustbin and filters properly before using the robot.
20. Do not use the robot in rooms where babies are sleeping.
21. Do not use damaged power cords or charging dock to recharge the robot.
Do not use the robot if it's damaged by falling down, or soaking in water.
22. Turn off the power switch if the robot will not be used for a long time.
23. Turn off the power switch before cleaning or maintaining the robot.
24. Unplug power cords from the charging dock before cleaning or maintaining the robot.
25. Remove battery before discarding the robot.
26. Robot and battery are to be disposed of according to local safety regulations.
27. Do not cremate the robot to avoid the explosion.
28. Follow the instructions in this user manual.
Manufacturer is not responsible for any damages caused by improper use.

Product Composition

List of accessories

Serial Number	Description	Q'ty
1	Main body (battery included)	1
2	Charging dock	1
3	Remote control (battery not included)	1
4	Power adapter	1
5	User manual	1
6	AAA battery	2
7	Extra side brushes	4
8	HEPA Filter	1

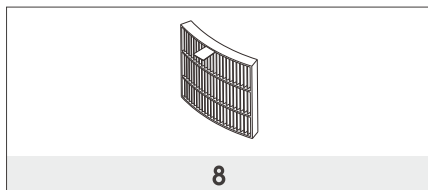
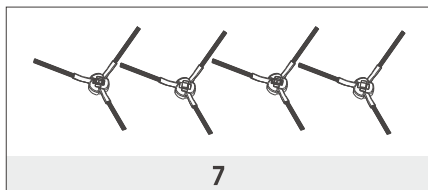
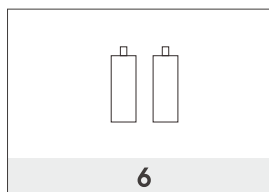
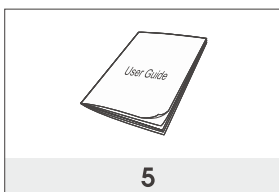
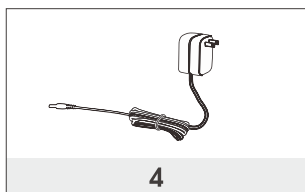
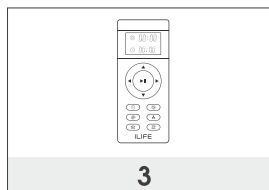
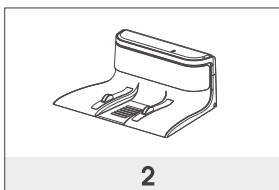
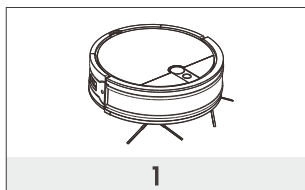

Product Composition

Robot anatomy

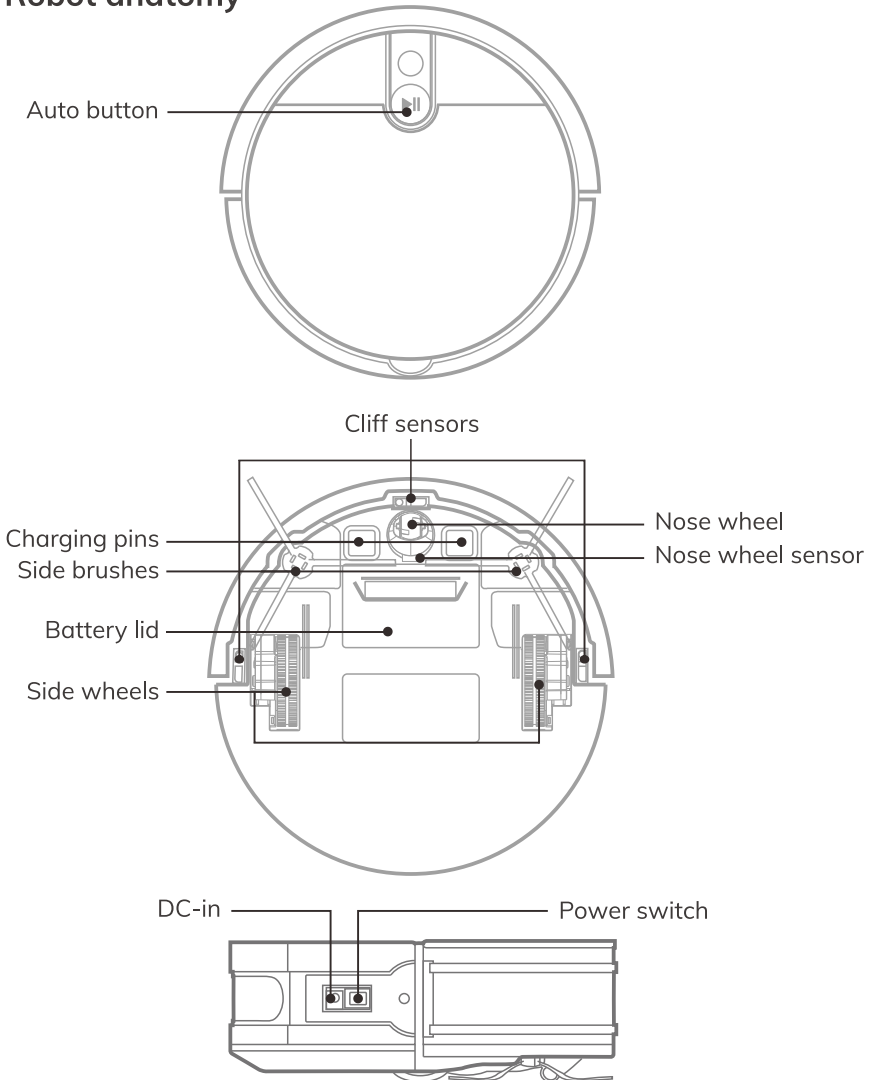

Product Composition

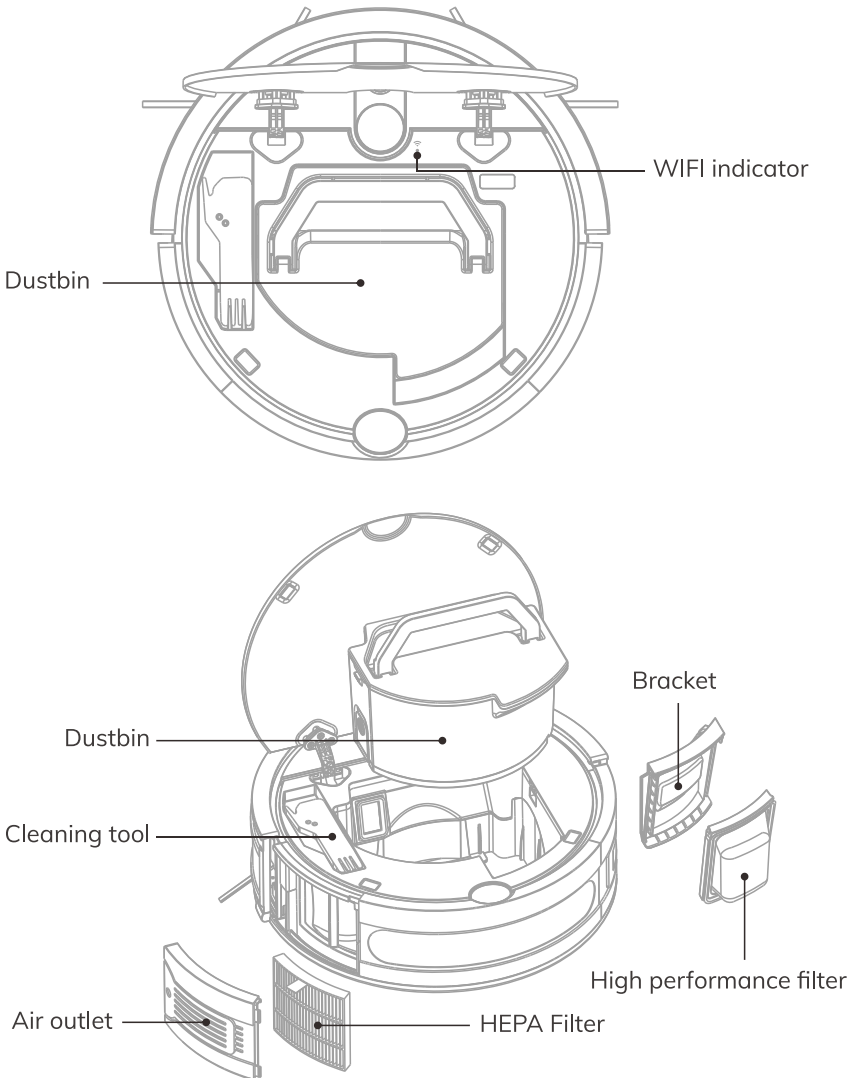

Product Composition

Dustbin

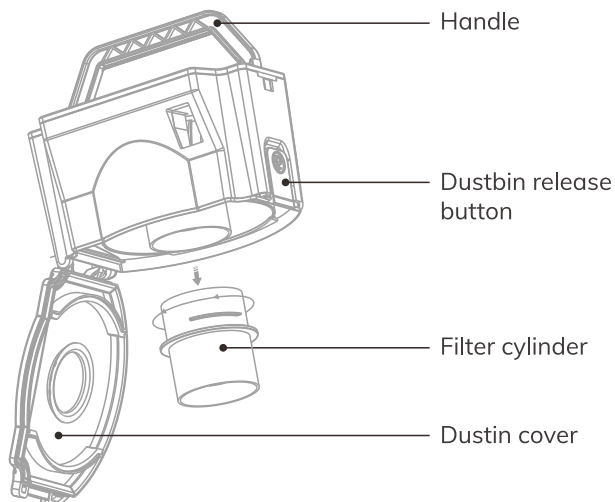

Remote control

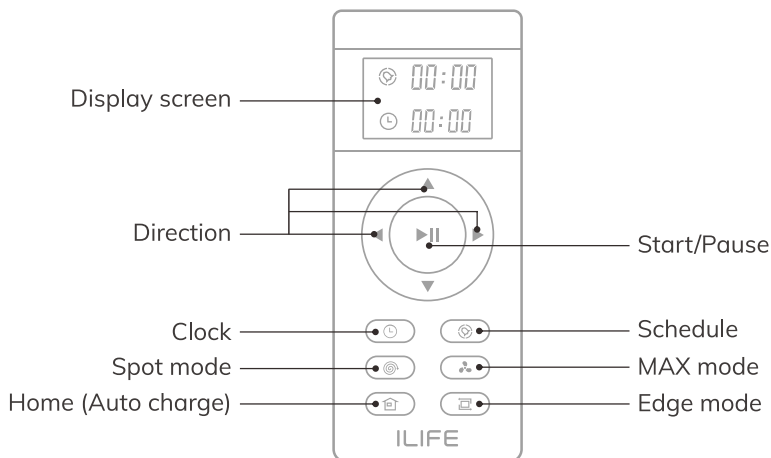

Product Composition

Product specifications

Item	Specification
Diameter	310mm
Height	112mm
Weight	2.9kg
Power	28W
Battery type	Li-ion
Charging type	Auto / Manually
Dustbin capacity	0.7L
Cleaning mode	Auto, Spot, MAX, Edge
Charging time	< 300mins
Cleaning time	> 90mins
Main body button type	Mechanical button

**Note:**

The company reserves the right of final decision on the interpretation of these terms and conditions.

Product Operation

Attentions

The robot may skip over some areas due to the complexity of the home environment. To achieve the best result, we suggest using it as daily routine and clearing up the obstructions on the floor before starting the robot.

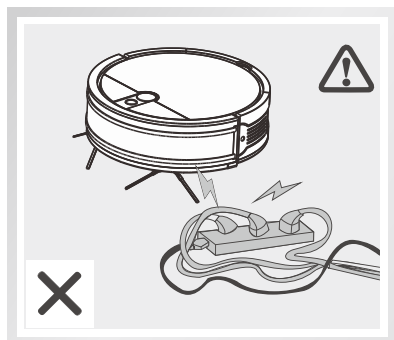

Please move away the power cords and other objects that may tangle the robot before cleaning.

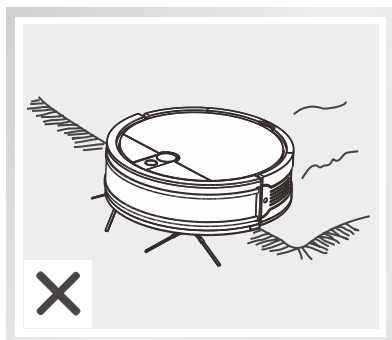

Please fold up the edges of the carpets before cleaning.



To avoid being stuck during cleaning, please arrange the furniture neatly.



Product Operation

Attentions

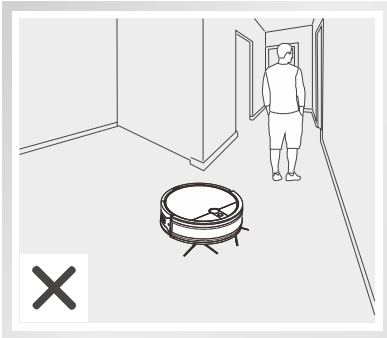

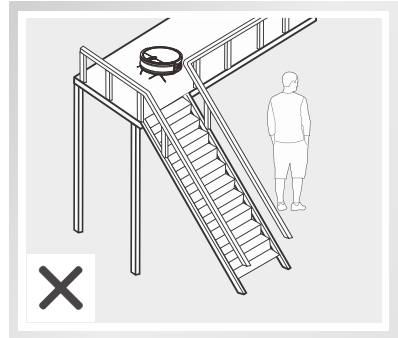

Please do not stand at somewhere with narrow space like the door sill or hallway in case of blocking the robot and skipping over some areas.

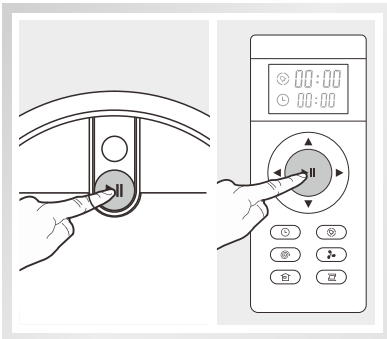

Please do not stand by downstairs when the robot is working upstairs in case of getting injured by any fallen objects.



The robot will be in sleep mode if it stops working for 10mins. To restart it, please press the  button or the  button on remote control.

Product Operation

Charging dock

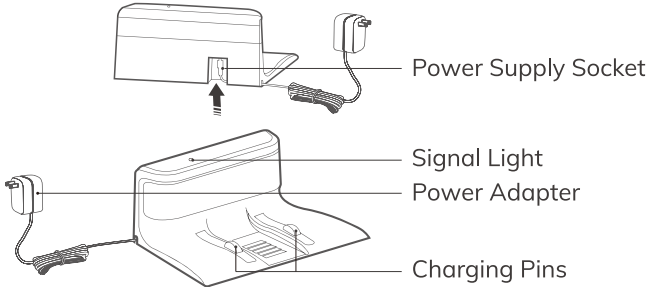

1 How to charge

- Connect the adapter with the charging dock.
- Put the charging dock against the wall and ensure there is no objects within 1 meter on both sides and 2 meters forward, and no reflective objects around, such as mirrors.
- Connect the power.

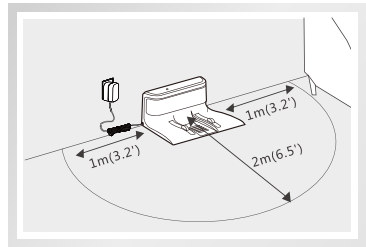
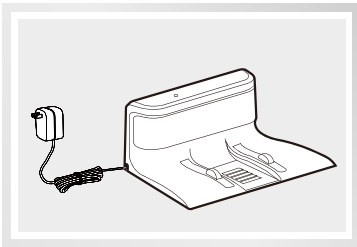

Note:

When the charging dock is connected to the adapter, the signal light of the dock will light up.

Product Operation

2 Turn on / off

- Turn on the power button on the side,
“ - ” for ON, “ O ” for OFF.



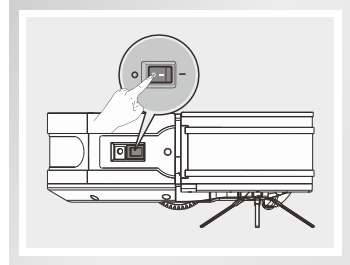

Note: After the robot finishes its work, please do not turn it off, and fully recharge it for the next run.



3 Charging

A. Charging automatically

1. Please place the robot on the charging dock.
2. If the  button is flashing in orange, the robot is charging.
If the  button is in green, the robot is fully charged.

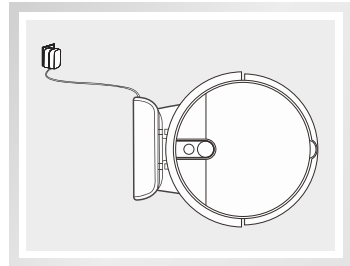

Note:

Please keep the charging pins clean in daily use to ensure a good connection.

B. Charging manually

- Turn on the power button on the side of the robot, connect the adapter with the robot and then plug the adapter into the power socket.

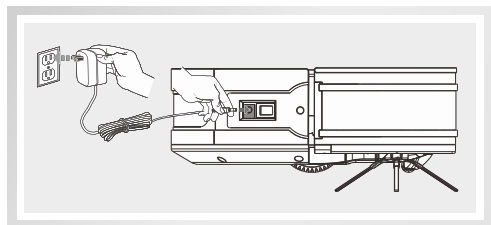



Product Operation





Note:

- Please leave the robot on the charging dock for daily use and make sure that the charging dock is connected to the power and the switch is on.
- If you won't use the robot for a long time, please fully charge it, turn off the power and keep it in a well-ventilated dry place.
- If the robot is scheduled for cleaning, please do not recharge it manually. Otherwise it will not perform properly.

4 Start cleaning

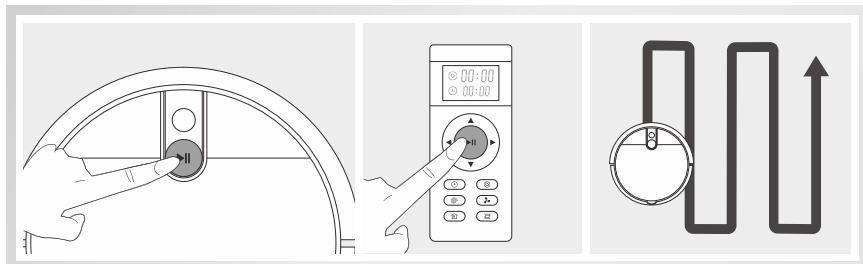

Press the  button on the robot or the  button on the remote control, the  button will turn to green and then the cleaning starts.



- * Before cleaning, please make sure the button  is in green. If the robot is in sleep mode, please press the button  on the robot to awaken it.
- * Please refer to the chapter of "Select cleaning modes" if you want to change the current cleaning mode.
- * The robot will automatically work out the optimum cleaning path. If the robot is moved manually or by remote control when running, the robot will work out a new cleaning path, and some areas cleaned before will be cleaned again. To ensure the cleaning efficiency, please do not move it when running.
- * The robot pauses shortly to work out the best cleaning path when running. Please do not be panic and wait for a moment. The times of it get paused depend on the complexity of the home environment.



Product Operation

5 Pause

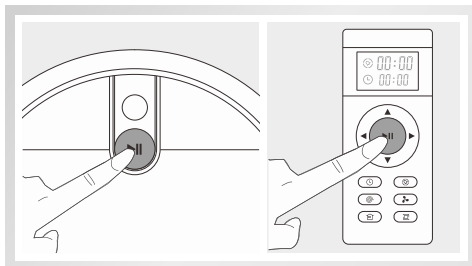
Press the  button on the robot or the  button on the remote control to stop it from working.



Note:

1. The robot will be in sleep mode if it stops working for 10mins. To restart it, please press the  button or the  button on remote control.
2. The robot will work out a new cleaning path, and will clean the areas again which have been cleaned before.

6 Sleep mode

- To enter the sleep mode:
 1. Press button  for three seconds.
 2. The Robot will automatically enter the Sleep Mode if no action is taken for 10 minutes.

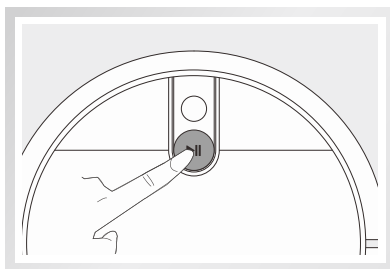



Product Operation

Select cleaning modes

For the best cleaning result on different floors, there are multiple cleaning modes available to satisfy different cleaning needs.



Note:

1. Please ensure that the robot is on standby, which means the button  should be in green. If the robot is in sleep mode, please press the button  on the robot or  on the remote control to awaken it.
2. When changing to other cleaning modes from auto mode, the robot will work out a new cleaning path, and the areas which are cleaned before will be cleaned again.

1 Auto mode

The default cleaning mode. The robot will clean in S-shaped path, and automatically recognize the missed areas and intelligently include them to new cleaning path.

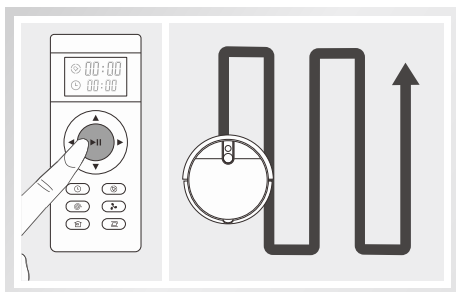

2 Spot mode

Recommend for localized areas with heavy stains. Press  button on the remote control to start Spot mode.

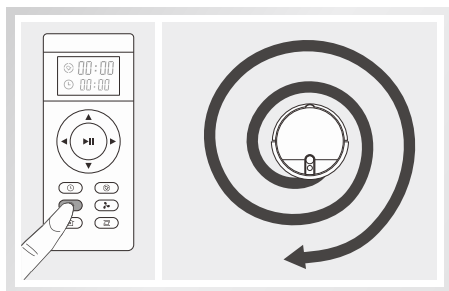



Product Operation

3 Edge mode

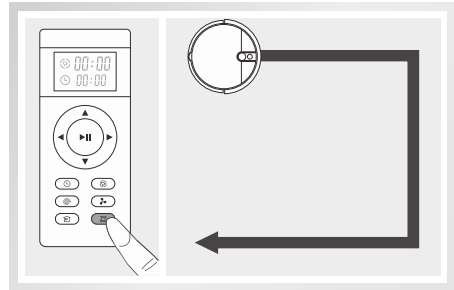
Recommend for cleaning the corners and along the walls.



4 MAX mode

It is suitable for the environment where the whole ground is dirty and with more dust. Press the  button of the remote control to increase the suction of the robot. Press the  button again to switch to normal suction.

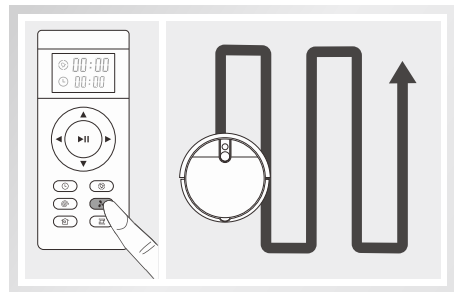

5 Auto charge

The robot can sense lower power during the cleaning process and automatically activate Self-charge Mode and search for the charging dock.

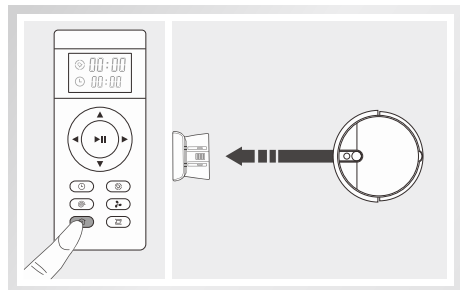



* You can also use the button  on the remote control to command the robot to activate the mode.

Product Operation



Schedule cleaning

To perform the best, the robot can be scheduled for cleaning. Local time and cleaning schedule can be set via remote control or ILIFE APP. Once schedule successfully, the robot will start cleaning at the same time everyday.

Before setting local time and cleaning schedules, make sure  button on the main body is switched on. A green flashing light indicates robot is activated from Sleep mode. To activate robot, tap  button on the main body or  button on the remote control.

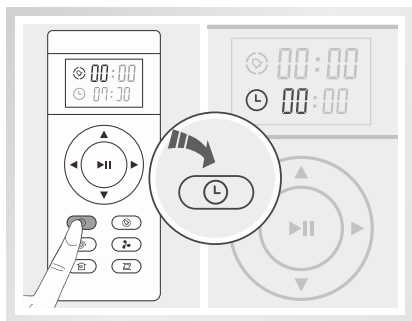
1 Set local time with remote control



Tap  button. The icon of  and  on the screen will flash.

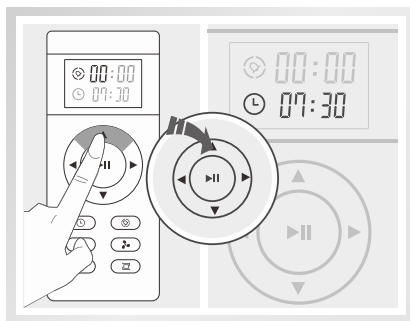

To set local time adjust time with “▲” “▼” button. To set local time press “◀” “▶” to change from hours to minute.

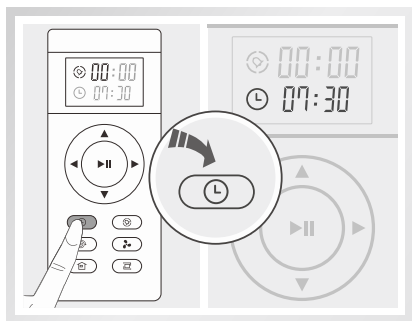

Press  again to save local time. Voice prompt will be heard if set up successfully.

Product Operation

2 Schedule time to clean

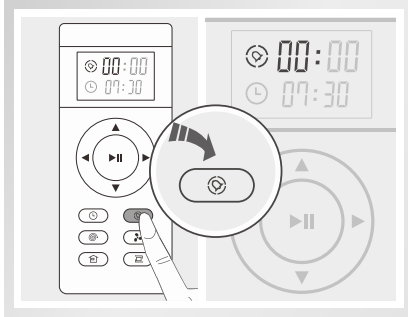

The icon of  and  on the screen will flash.

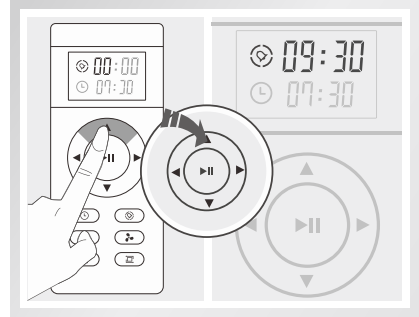

Use direction buttons to adjust schedule time.

Press  again to save the time for cleaning. Voice prompt will be heard if setup successfully, and the robot will start cleaning at the specific time everyday.

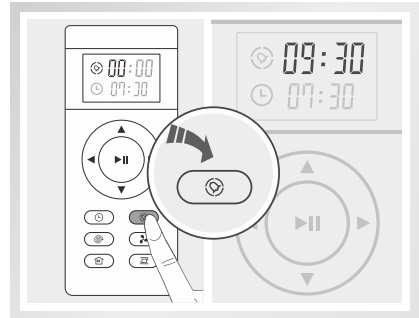

3 Cancel a schedule

Press , and adjust time to "00:00" and save, or turn off the power of the robot.

- Please pay attention to the prompt to see if the robot is successfully scheduled.
- Rescheduling is required after changing batteries in the remote control.

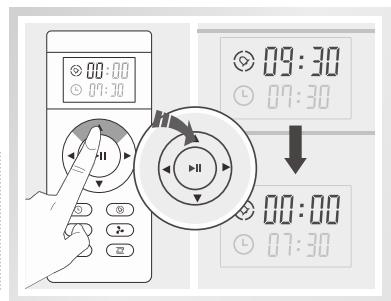

APP Download

Downloading the App

The robot can be controlled by the “ILIFEHOME” app. Scan the QR code to install the app on your iOS or Android device.



Maintenance

Clean up dustbin and filters

* Please turn off the robot before cleaning any spare parts, and remember to cut off the power.

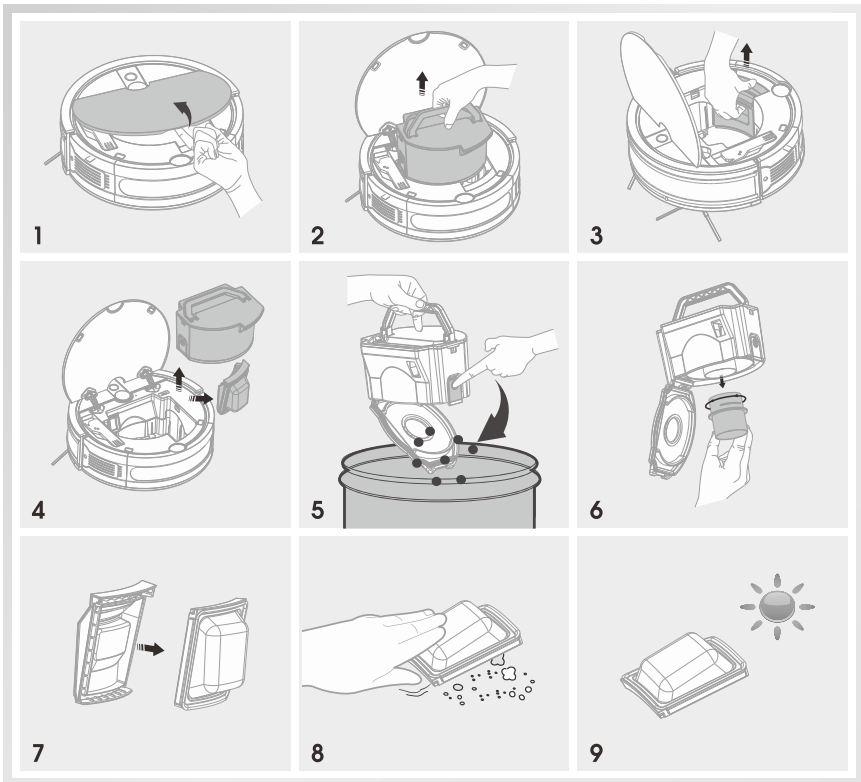

1. Open the cover, take out the dustbin and high-performance filter. Press the button on dustbin to release all dust. Spin around the filter and take it out, rinse it with clean water and wipe it up.
2. Take out the high-performance filter. Slightly tap it to empty the dust in it. Rinse it with clean water and dry it in the air.

Maintenance

Clean up the side brushes

- Take off the side brushes, wipe the dust off with clean cloth.

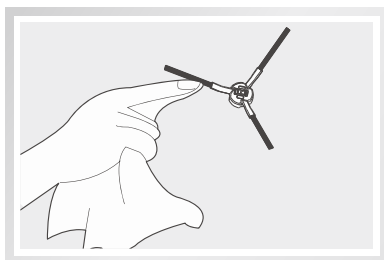

Clean up the HEPA filter

Open the cover, take out the HEPA filter. Slightly tap it to empty the dust in it. (Do not rinse it in water and keep it dry.)

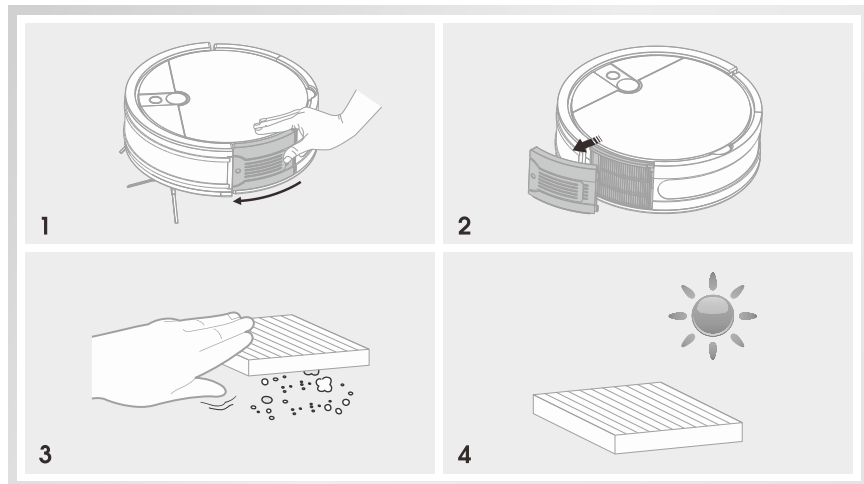

Maintenance

Install dustbin and filter

Set up filter and dustbin

1. Set up the high-performance filter and put it into the side slot of the robot and push. It's well-installed if a sound of "ding" heard.
2. Hold the handle and put the dustbin in, then rotate the handle and put it down. Close the cover.

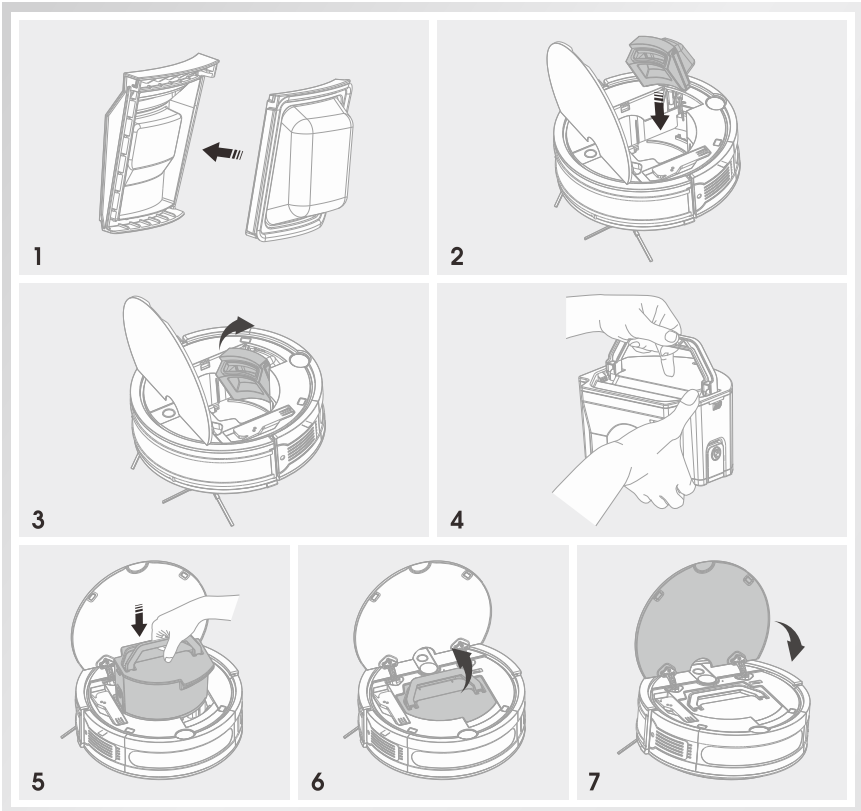

Maintenance

Install the air outlet

1. Put the HEPA filter into the side slot of the robot, then close the cover and push it backward till it's locked.

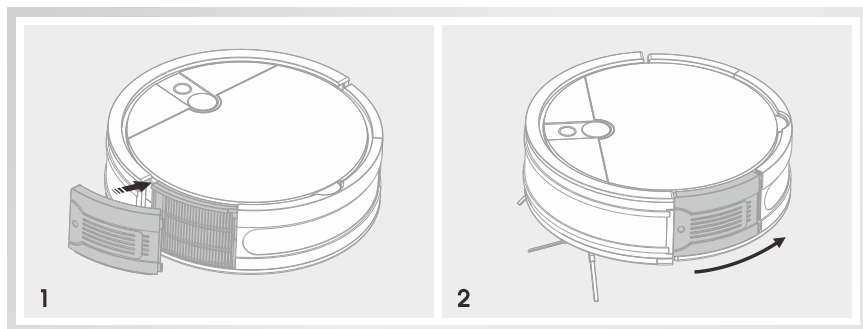

Other spare parts

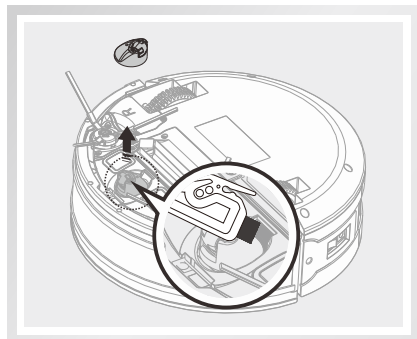

Clean the nose wheel regularly to avoid being tangled by hair.

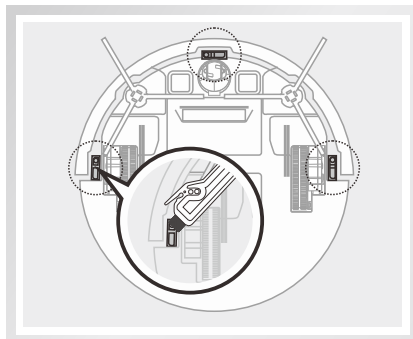

Clean up sensors regularly to maintain the sensitivity.

Maintenance

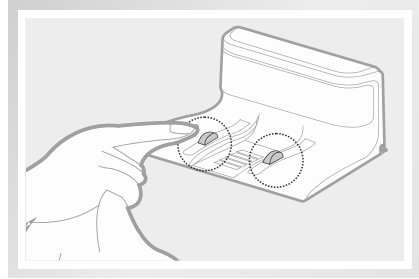
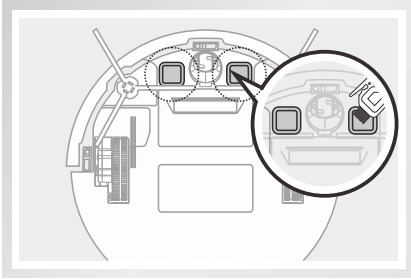

Clean the charging pins on the robot and the charging dock regularly with dry cloth.

- * When the battery is in the depth of discharge state or not in use for a long time, its capacity will be reduced. In this case, we suggest you to activate it again. Charge the robot on the charging dock for 3mins, and repeat 3 times, then fully charge the robot for 3-5hours.
- * The robot uses long cyclic life batteries. There is no need to replace it frequently. Please contact our support team if necessary.

Replace accessories regularly

Accessories	Maintenance	Replacement
Dustbin	After each use	N/A
High-performance filter	Weekly (twice a week for families with pets)	Every 3-5 months
HEPA filter	Triweekly (once a week for families with pets)	Every 6-12 months
Side brush	Weekly	Depends
Charging dock	Weekly	N/A

Troubleshooting

Error codes

The robot will remind you by beeping when it is malfunctioning.

- Short tones

NO.	Tone	Possible Cause	What to do
01	•	Wheels or side brushes problems.	Check wheels and side brushes.
02	• •	Cliff sensor or bumper sensor failure.	- Clean cliff sensor. - Gently shake the bumper to check if there's anything stuck in it.
03	• • •	- Robot gets stuck. - Dustbin not installed.	- Pick up robot and restart. - Install the dustbin.

Troubleshooting

Error symptoms

Symptoms	Possible cause	Solution
Circle around a small area.	Side wheels are jammed.	<ul style="list-style-type: none"> - Remove hair and debris from side wheels. - While reinstalling, push the wheels in and out to make sure they can rotate freely. - Restart robot in another spot .
Keep moving backward.	A Cliff sensor is dirty or broken.	<ul style="list-style-type: none"> - Check cliff sensor lens. - Clean or replace it if needed.
Bump into obstacles repeatedly.	The bumper is stucked.	<ul style="list-style-type: none"> - Tap the bumper 10-20 times to remove debris lodged in it. - Loosen the screw of the bumper.
Working time shortened.	<ul style="list-style-type: none"> - Battery capacity dropped. - Robot is not fully charged. 	<ul style="list-style-type: none"> - Replace battery. - Recharge robot.
CLEAN button light is off while charging.	<ul style="list-style-type: none"> - Hair or small debris stuck in charging pins. - Robot is not properly connected to charging pins. 	<ul style="list-style-type: none"> - Clean charging pins. - Check if robot is connected to charging pins.
Pick up less dirt and debris.	Filter is dirty or wet.	Clean or replace filter.
Spit out litter.	Dustbin is full.	Empty the dustbin.
Robot doesn't start at scheduled time.	<ul style="list-style-type: none"> - Schedule was not saved successfully. - Schedule was canceled after you restarted robot. - Power Switch is off. - Battery is low. 	<ul style="list-style-type: none"> - Reset schedule. Wait for a beep to confirm completion of scheduling. - Turn on the power switch on robot. - Keep robot's power switch on and put it on charging dock to make sure robot is fully charged for the next job.
Long distance retreat frequently in a short period of time.	The sensors of nose wheel has dirty.	Please clean the sensors of nose wheel.