

ILIFE

User Manual

Robotic vacuum cleaner

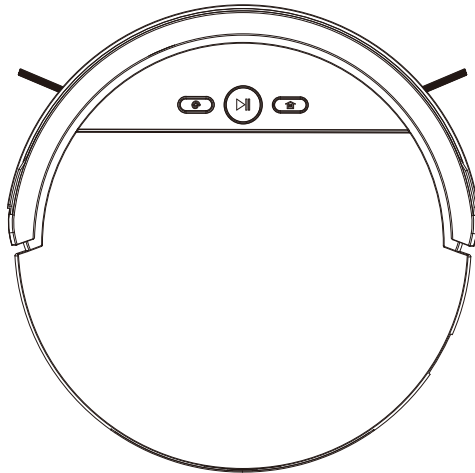

Thank you for choosing ILIFE V4 robotic vacuum cleaner!
You've joined millions of people to get cleaning done robotically.

This user manual helps you to keep your robot performing at its best. Please take a few moments to read through it.

You are entitled to the exclusive benefits once you register your robot at www.iliferobot.com/register:

- Access to ILIFE 24-hour online customer support;
- Get first-hand updates, including new model launch and exclusive discounts.

As a registered user, you could also share your robotic cleaning experience with us. ILIFE listens and makes product improvements based on your valuable feedbacks.

If you have any questions, please contact our customer service for assistance or visit www.iliferobot.com for more information.

Enjoy automated home cleaning performed by ILIFE V4!

Important Tips

Operate

- Make sure the power switch is turned on before using the robot. Check the areas that need to be cleaned and remove obstacles on the floor.
- Robot will repeat cleaning the same areas a few times to ensure they are thoroughly cleaned.
- There may be small particles such as dog food and cat litter scattering on the floor while the spinning brushes are working. The vacuuming function will clear up the debris.
- When replacing the side brushes, make sure they are installed according to the "L" and "R" marks on both sides of the brush and the base of the robot.
- Successful clock and schedule settings will be confirmed by a "beep" sound.
- Empty the dustbin if the robot vacuums less or spits debris out. No alert will be given for a full dustbin.

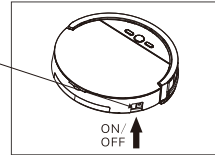

For best performance

- Empty the dustbin and clean the high-performance filter after each use.
- Filter could not be washed with water.
- Replace the high-performance filter when suctioning power weakens or when the robot picks up less debris.
- Put the charging dock against a wall and remove obstacles about 1 meter on both sides and about 2 meters in front.
- Fully charge the robot before each operation.

Extending battery life

To extend V4's battery life and keep its cleaning performance at its best:

- Before first use, charge the robot overnight.
- If the robot will not be used for a long time, switch the power off.
- Recharge the robot soon after each use. Robot in low battery status may damage the battery.
- Use the robot regularly.

Warning



V4 contains electronic parts. Do NOT put it in water or spray it with water. Clean the robot with a dry cloth only.

Table of Contents

Safety Instructions	1
Product Parts	2
Main body and accessories	2
Robot anatomy	3
Charging dock and remote control	4
CLEAN button signals	5
Remote control operation	6
Product Operation	8
Getting started	8
Start/Pause/Sleep	9
Schedule	10
Cleaning modes	11
Maintenance	12
Side brushes	12
Dustbin and filters	12
Cliff sensors and auto charging ports	12
Front wheel	13
Troubleshooting	14
Error codes	14
Error symptoms	15
Product Specifications	16

Safety Instructions

Before using the robot, please read and follow the safety instructions and precautions below.

- Read through this user manual carefully before using the robot.
- Retain this user manual.
- Any operation that is not described in this user manual may injure the users and cause product damage.

WARNINGS

1. Only certified technicians may disassemble the robot. Users must not disassemble or repair the robot.
2. Use factory authorized adapter only. Using nonspecific adapter may cause electric shock, fire or robot damage.
3. Do not touch the power cord, plug or adapter with wet hands.
4. Do not allow clothes or any part of your body to be drawn into the robot's wheels.
5. Do not place the robot near cigarette, lighter, matches or other flammables.
6. Clean the robot after charging finishes.
7. Do not over-bend the power cord or pressure the power cord with heavy or sharp objects.
8. Do not use the robot outdoor.
9. Do not sit on the robot or attach any object on it.
10. Do not use the robot on wet floors.
11. Before using the robot, remove all fragile objects (textile, glass, lighting, etc) and other objects that could get caught in the brushes or suction opening (cords, clothing, papers, drapes, blinds, etc) on the floor.
12. Do not place the robot where it could easily fall off (tables, chairs, etc).
13. Turn off the power switch during transportation or when the robot will not be used for a long time.
14. To avoid battery damage, check if the adapter and outlet are properly connected before using the robot.
15. To avoid tripping, make sure everyone in the house knows the robot is working.
16. Use the robot in environment between -10° and 40° Celsius.
17. Do not place the robot in high-temperature environment.
18. Before scrapping the battery, remove it from the robot.
19. Disconnect electricity supply before removing the battery.
20. The battery is to be disposed of safety according to local regulations.

NOTE: This robot should not be used by children, mentally challenged people or people who lack related experience and knowledge (unless they are under proper supervision).

Product Parts

Main body and accessories

NO.	Description	Qty
1	Main Body (battery included)	1
2	Charging Dock	1
3	Remote Control (battery not included)	1
4	Power Adapter	1
5	Cleaning Tool	1
6	User Manual	1
7	Extra Side Brushes	1 for each
8	High Performance Filters	2

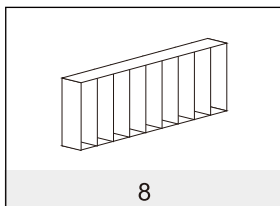
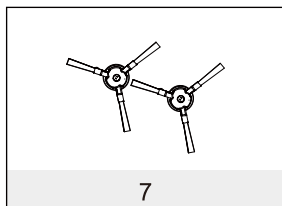
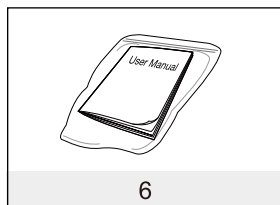
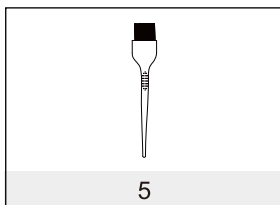
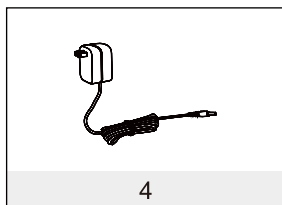
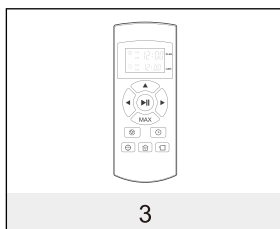
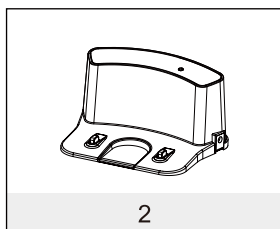
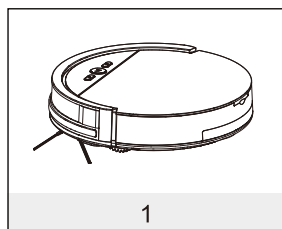

Product Parts

Robot anatomy

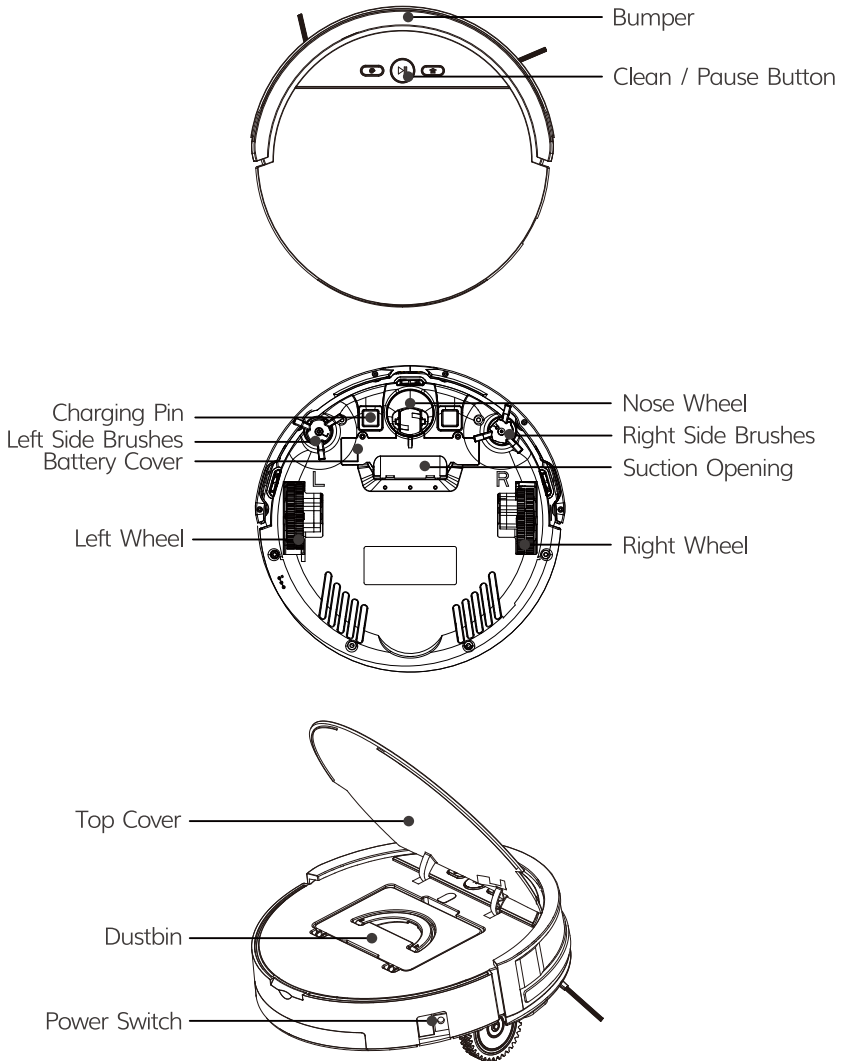

Product Parts

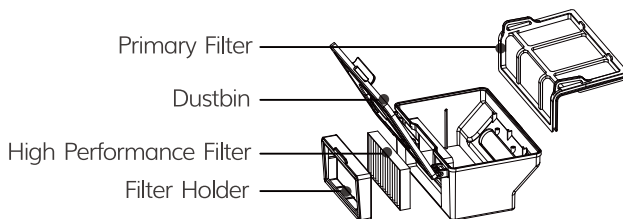

Charging dock

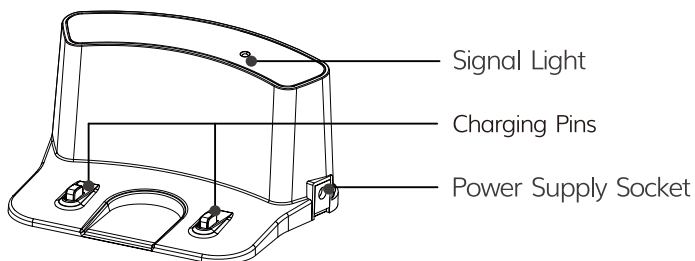

Remote control

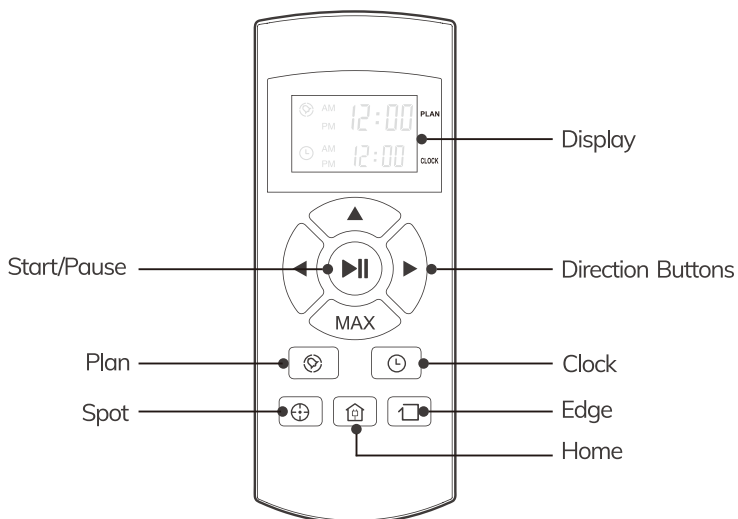

Product Parts

CLEAN button signals

Robot Status	Light signal
Charging	Middle light in orange flash steadily
Charging finished	All lights off
In selected mode	Three lights flash in green
Malfunctioning	Middle light flash slowly in red
Low battery	Middle light in orange turns solid
In home mode	Home button turns solid
In cleaning mode	Middle light in green turns solid
In edge mode	Middle light in green turns solid
In spot mode	Spot button turns solid

Product Parts

Remote control operation

1 Start/Pause

- To start cleaning in selected mode.
- To stop current cleaning cycle.
- To change from sleep mode to selected mode.

2 Direction Buttons

A. "▲" Button

- To increase minute and hour setting in schedule or clock mode.
- To move the robot forward in selected mode.
- To stop the robot when it hits against objects.

B. "MAX" Button

- To decrease minute and hour setting in schedule or clock mode.
- To move robot backward in selected mode.
- Press "MAX", the vacuum power will be the strongest.

C. "◀" Button

- To change from minute to hour in schedule or clock mode.
- To turn the robot left.

D. "▶" Button

- To change from minute to hour in schedule or clock mode.
- To turn the robot right.

3 "Plan" Button

- To enter schedule mode when robot is in selected mode.
- To confirm scheduled cleaning.

4 "Clock" Button

- To enter clock mode when robot is in selected mode.
- To confirm time setting.

5 "HOME" Button

To return robot to charging dock.

Product Parts

6 "Edge" Button 

To clean along the edge of the walls.

7 "Spot" Button 

To start cleaning specific areas.

8 00:00  AM 

To display scheduled time.

9 00:00  AM 

To display clock.

Note:

1. Place two AAA batteries into the remote control.
2. Remove batteries if the remote control will not be used for a long time.

Product Operation

1. Getting started

1>. Place the charging dock on the floor and plug in the adapter. Signal light on charging dock will turn solid.

Note: Put charging dock against a wall and remove obstacles about 1 meter on both sides and about 2 meters in front.

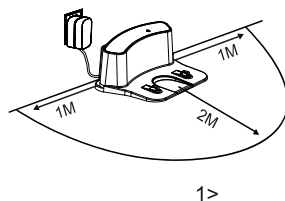

2>. Display panel will flash after power switch (near power socket) is turned on. (If no command is received, the robot will switch to sleep mode after 45 seconds.)

Note: A. Always keep the power switch on, otherwise the robot will not work.
B. If power switch is turned off, all scheduled cleaning will be lost.

Caution: Before charging the robot, make sure the power switch is turned on, or the robot will not be charged.

3>. Robot can be recharged by:

- A. plugging into an outlet;
- B. pressing  button on remote control – the robot will return to charging dock for auto recharge.

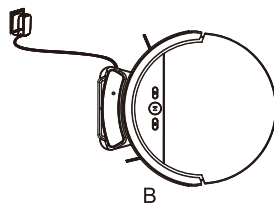
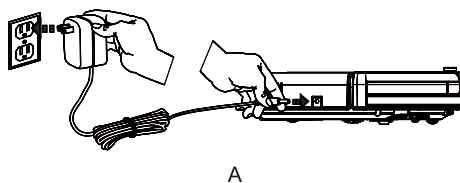

Extending battery life:

- A. Before first use, charge the robot overnight. When charging is finished, light at main button will turn off.
- B. Always place the robot on charging dock that is connected to power.
- C. If the robot will not be used for a long time, fully recharge the robot and turn the power switch off before storing it in a cool, dry place.

4>. Auto charging

The robot will automatically return to the charging dock when its battery runs low.

Product Operation

2. Start/Pause/Sleep

Sleep mode: robot is not working, light at  button is off and power switch is on.

Selected mode: robot is not working, green light at  button flashes.

Cleaning mode: robot is working, green light at  button turns solid.

1>. Start

A. Make sure the power switch is turned on.

B. Press  button on robot or remote control to start cleaning.

Note: If robot is in sleep mode, press  button to reactivate it.

Press  button again to start the operation.

2>. Pause

Press  button on robot or remote control to change robot from Clean mode to selected mode.

Note: When robot is paused, press  button to resume the operation.

3>. Sleep

To switch the robot from selected mode to sleep mode:

A. Press and hold  button on robot for 3 seconds.

B. Robot automatically enters sleep mode if no command is received after 15 seconds.

Product Operation



3. Schedule

You can preset a cleaning routine for your robot.

Note: Reset the clock and reschedule a cleaning cycle after replacing battery.



Robot will only start cleaning automatically after the clock and schedule are set.

Set the clock

1. Point the remote control at robot (make sure the power switch is on).
2. Press  button and adjust to your local time.
3. Press  button again to save the setting.
4. Turn off power switch on robot to cancel the schedule.

Set a schedule

Robot starts a cleaning schedule only when its power switch is on.

1. Point the remote control at robot.
2. Press  button and adjust time with direction buttons.
3. Press  button to save the setting.
4. Turn off the robot to cancel the schedule.

Note: Successful clock and schedule settings will be confirmed by a "beep" sound.
Reset the schedule if there is no sound confirmation.

Product Operation

4. Cleaning modes



1>. Auto cleaning

In Auto Cleaning mode, robot automatically cleans the areas it can reach.

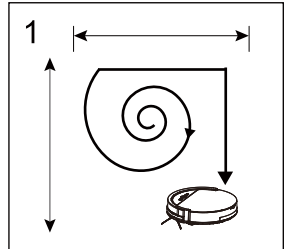
Note: Press  button on robot or remote control to start Auto Cleaning.



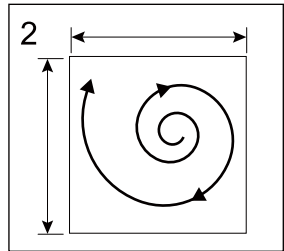

2>. Spot cleaning

- Point remote control at robot and press  button while it is cleaning. Robot will clean around a circular route and return to Auto Clean mode after Spot cleaning is finished.
- Point remote control at robot and press  button when robot is in selected mode. Robot will clean around a circular route and return to selected mode after Spot cleaning is finished.



3>. Edge cleaning

To start edge cleaning, put the robot near the edge of a wall and press  button on remote control.

Note: Edge cleaning will automatically stop if the robot cannot detect any edges. To stop edge cleaning manually, press  button.

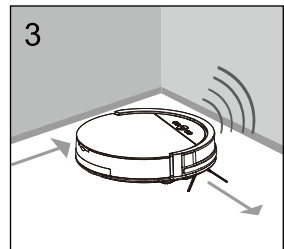

Maintenance

1. Side brushes

Clean the side brushes when they get dirty. Replace them if they are damaged.

Note: When replacing the side brushes, make sure they are installed according to the "L" and "R" marks on both sides of the brush and the base of the robot.

2. Dustbin and filter

Follow the below steps to empty and clean the dustbin after each use.

- Take out the dustbin and clean dust or debris in the suction opening.
- Clean the high performance filter after 15-30 days of use. Replace it no more than 6 months of use.
- Do not reinstall the high performance filter and primary filters when they are still wet.
- Replace the high performance filter and primary filter if needed.

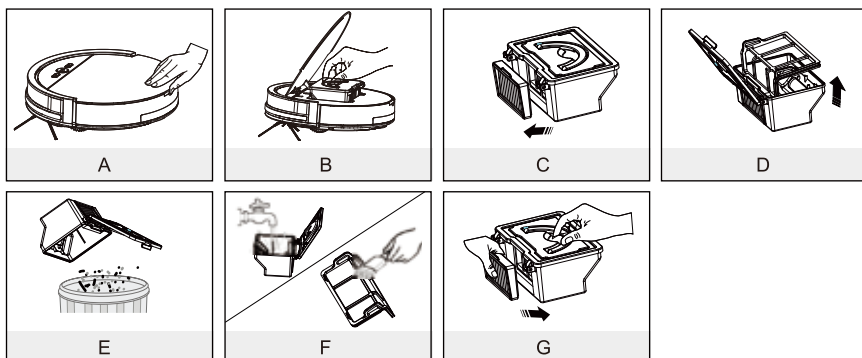

3. Cliff sensors and auto charging pins

Gently clean the sensor lens and auto charging pins with a soft dry cloth.

Note: Charging pins need to be cleaned if they become dirty.

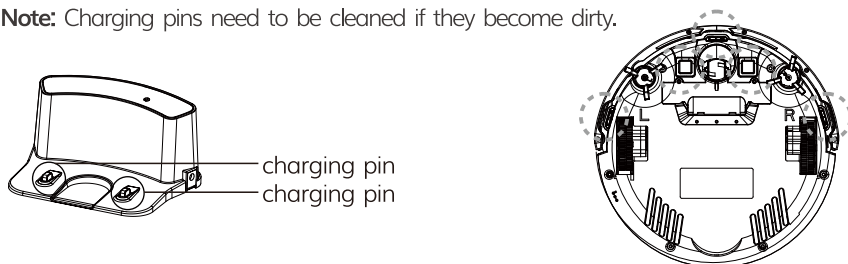

Maintenance

4. Front wheel

Make sure the front wheel is clean to avoid lowered cleaning performance:

- (1) Pull the wheel up and out vertically and clean it. Also check if the gasket is worn.
- (2) Ensure that the gasket is properly installed after cleaning the front wheel.

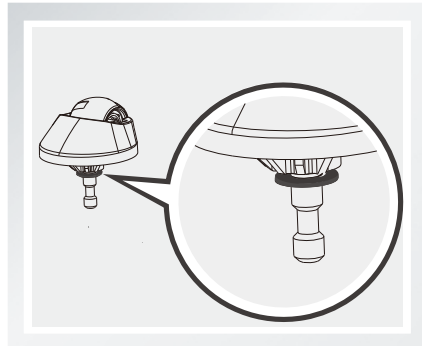
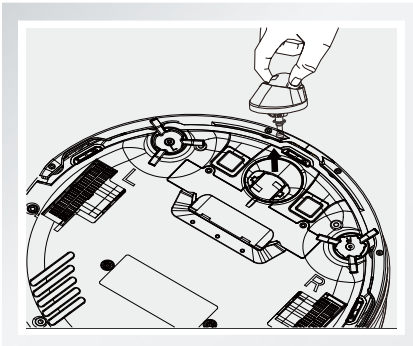

Troubleshooting

Error codes

The robot will remind you by beeping when it is malfunctioning.

• Short tones

NO.	Tone	Possible Cause	What to do
01	•	Wheels or side brushes problems	Check wheels and side brushes
02	• •	Cliff sensor or bumper sensor failure	<ul style="list-style-type: none"> • Clean cliff sensor • Gently shake the bumper to check if there's anything stuck in it
03	• • •	Robot gets stuck	Pick up robot and restart

Note: If none of the above solutions works, try the following:

1. Turn power switch off and on to reset the robot.
2. If resetting doesn't help, contact the seller for repair service.

Troubleshooting

Error symptoms

Symptoms	Possible Cause	Solution
Circle around a small area	Side wheels are jammed	<ul style="list-style-type: none"> - Remove hair and debris from side wheels - While reinstalling, push the wheels in and out to make sure they can rotate freely - Restart robot in another spot
Keep moving backward	A Cliff sensor is dirty or broken	<ul style="list-style-type: none"> Check cliff sensor lens Clean or replace it if needed
Bump into obstacles repeatedly	The bumper is stucked	<ul style="list-style-type: none"> - Tap the bumper 10-20 times to remove debris lodged in it - Loosen the screw of the bumper
Working time shortened	<ul style="list-style-type: none"> - Battery capacity dropped - Robot is not fully charged 	<ul style="list-style-type: none"> - Replace battery - Recharge robot
CLEAN button light is off while charging	<ul style="list-style-type: none"> - Hair or small debris stuck in charging pins - Robot is not properly connected to charging pins 	<ul style="list-style-type: none"> - Clean charging pins - Check if robot is connected to charging pins
Pick up less dirt and debris	Filter is dirty or wet	Clean or replace filter
Spit out litter	Dustbin is full	Empty the dustbin
Robot doesn't start at scheduled time	<ul style="list-style-type: none"> - Schedule was not saved successfully - Schedule was canceled after you restarted robot - Power Switch is off - Battery is low - Debris jammed in components 	<ul style="list-style-type: none"> - Reset schedule. Wait for a beep to confirm completion of scheduling - Turn on the power switch on robot - Keep robot's power switch on and put it on charging dock to make sure robot is fully charged for the next job - Turn off the power switch on robot and empty the dustbin - Clean side brushes and main brushes

Product Specifications

Classification	Specification	Detail
Mechanical	Diameter	300mm
	Height	77mm
	Net weight	2.16kg
Electrical	Battery type	Li-ion
	Power	20W
	Charging type	Auto / Manual
Cleaning	Capacity of dustbin	0.3 L
	Cleaning modes	Auto/Spot/Edge/Schedule
	Duration per recharge	About 280 mins
	Duration per cleaning	Up to 120 minutes
Main Body Button		Mechanical Button

Remark: The storage temperature of this product is between -10°C and 40°C.